

User manual

User manual no:
IMMU-14-04-12-14-ENG

MOISTURE ANALYZER MA R SERIES



BALANCES AND SCALES

RADWAG 26 – 600 Radom, Bracka 28, POLAND
Phone: +48 48 38 48 800, phone/fax: +48 48 385 00 10
Sales department: +48 48 366 80 06
export@radwag.com
www.radwag.com

DECEMBER 2014

1.	TECHNICAL SPECIFICATION	6
2.	GENERAL SAFETY INFORMATION	7
2.1.	Signals and warning signs	7
2.1.1	Warning descriptions	7
2.1.2	Warning signs	8
2.2.	Safety information	8
2.3.	Intended use	11
2.4.	Inappropriate use	11
2.5.	Principles of safety use	12
2.6.	Warranty	12
2.7.	Metrological parameters monitoring	12
2.8.	Data included in this user manual	13
2.9.	Staff competence	13
2.9.1.	Protective clothing	13
3.	TRANSPORT AND STORAGE	14
3.1.	Delivery check	14
3.2.	Packaging	14
4.	UNPACKING, ASSEMBLING AND STARTUP	14
4.1.	Assembling and place of use	14
4.2.	Unpacking	15
4.3.	Level setting	16
4.4.	Standard delivery components	16
4.5.	Cleaning	16
4.6.	Plugging to mains	16
4.7.	Connecting peripheral equipment	17
5.	KEYBOARD	18
6.	START-UP	19
6.1.	Temperature stabilisation period	19
7.	USER MENU	20
7.1.	Operating user menu	20
7.2.	Return to weighing mode	22
8.	LOGGING IN	23
9.	WEIGHING	25
9.1.	Required weighing procedures	25
9.2.	Zeroing	27
9.3.	Tarring	27
9.4.	<WEIGHING> mode settings	29
9.4.1.	Filter level setting	30
9.4.2.	Value release	31
9.4.3.	Autozero function	31
9.4.4.	Displaying the last digit	32
9.4.5.	Ambient and environmental conditions	32
9.5.	AUTOTARE	32
9.6.	Printing mode	33
9.7.	Information	35
9.8.	Non-standard information	35
9.9.	F button shortcuts	36

10.	OTHER PARAMETERS.....	37
10.1.	Available menu languages.....	37
10.2.	Access levels.....	37
10.3.	„Beep” sound – response to pressing function button.....	38
10.4.	Backlight and adjusting display brightness.....	38
10.5.	Backlight turn-off time.....	38
10.6.	Auto switch-off.....	38
10.7.	Date.....	39
10.8.	Time.....	39
10.9.	Date format.....	39
10.10.	Time format.....	40
11.	INFORMATION ON BALANCE.....	40
12.	BALANCE ADJUSTMENT.....	41
12.1.	Adjustment menu settings.....	41
12.2.	Manual adjustment.....	42
12.2.1.	Internal adjustment.....	42
12.2.2.	User adjustment.....	43
12.3.	Adjustment report printout.....	44
12.4.	Temperature adjustment (P1.3 THERM CAL).....	44
12.5.	Drying process test (P1.4 TEMPERATURE TEST).....	48
13.	DETERMINING PRINTOUT CONTENT.....	50
13.1.	Adjustment report.....	50
13.2.	Header printout.....	52
13.3.	Printout of measurement result – GLP PRINTOUT.....	54
13.4.	Footer printout.....	56
13.5.	Printout of report on drying process.....	58
13.5.1.	Report on drying – header.....	59
13.5.2.	Report on drying – measurement.....	60
13.5.3.	Report on drying – footer.....	61
13.6.	Non-standard printouts.....	62
13.6.1.	Inserting texts.....	62
13.7.	Variables.....	65
14.	DATABASES.....	66
14.1.	Users.....	66
14.2.	Products.....	69
14.3.	Drying programs.....	70
14.4.	Tares.....	72
14.5.	Weighments.....	73
14.6.	Reports on drying process.....	76
15.	DATABASES EKSPORT AND IMPORT.....	80
15.1.	Database export.....	81
15.2.	Database import.....	82
15.3.	Measurement data printout.....	82
16.	PREPARING SAMPLES FOR DRYING.....	84
16.1.	Rules for measurement of moisture analyzer humidity content.....	84
16.2.	Sampling and preparation.....	84
17.	SELECTION OF DRYING PARAMETERS.....	88
17.1.	Selecting optimum mass for a sample.....	88

17.2.	Influence of sample weight on measurement result repeatability.....	88	
17.3.	Drying temperature	88	
17.4.	Selecting drying mode	89	
17.5.	Drying time.....	90	
17.6.	Drying mode analysis	91	
18.	FUNCTIONS	92	
19.	DRYING PROCESS PERFORMED BY MEANS OF QUICK MENU	93	
19.1.	Drying process mode and drying parameters	93	
19.2.	Auto off mode	97	
19.3.	Unit of displayed and printed measurement	98	
19.4.	Interval for measurement printout	99	
20.	DRYING PROCESS PERFORMED WITH THE USE OF DRYING	PROGRAM LIBRARY	100
21.	DRYING PROCESS	101	
22.	COMMUNICATION.....	105	
22.1.	RS232 ports settings	105	
22.2.	USB port	106	
22.3.	WIFI port settings.....	111	
23.	PERIPHERALS	113	
23.1.	Computer	113	
23.1.1.	Port for computer connection.....	113	
23.1.2.	Continuous transmission.....	114	
23.1.3.	Printouts interval for continuous transmission.....	114	
23.1.4.	Cooperation with E2R.....	115	
23.2.	Printer	115	
23.3.	Barcode reader	118	
24.	COOPERATION WITH PERIPHERALS (PRINTER, COMPUTER	ETC.).....	119
24.1.	Cables	120	
24.2.	Transferred data format.....	120	
24.3.	Format of data sent on pressing PRINT button.....	120	
24.3.1.	Format of data sent as response for commands generated from a computer.....	121	
25.	COMMUNICATION PROTOCOL.....	122	
25.1.	List of commands.....	122	
25.2.	Responses format to commands sent from a computer level	123	
25.3.	Commands description	124	
26.	ERROR MESSAGES	131	
27.	USING MOISTURE ANALYZER	132	
28.	ADDITIONAL EQUIPMENT	133	
28.1.	Anti-vibration table	133	
29.	MAINTENANCE ACTIVITIES	134	
29.1.	Cleaning moisture analyzer components.....	134	
26.1.	Temperature sensor cleaning	134	
26.2.	Troubleshooting.....	135	

1. TECHNICAL SPECIFICATION

Balance type	MA 50/1.R	MA 50.R	MA 110.R	MA 210.R
Max capacity	50 g	50 g	110 g	210 g
Reading unit	0,1 mg	1 mg	1 mg	1 mg
Tare range	- 50 g	- 50 g	- 110 g	- 210 g
Max. Sample weight	50 g	50 g	110 g	210 g
Accuracy of moisture content reading	0,0001%	0,001 %		
Repeatability of moisture content reading	+/-0,1% (sample ~ 2g), +/-0,02% (sample ~10g)			
Drying temperature range	Max. 160 °C Max. 250 °C (WH)			
Heating module	IR emitter (NP) Halogen (NH or WH) Metal heater (NS)			
Drying modes	4 modes: standard, quick, step, mild			
Auto switch-off options	3 modes: automatic, time-defined, manual			
Working temperature	+10 °C - +40 °C			
Power supply	230V 50Hz AC / 400W			
Display	LCD (backlit)			
Weighing pan size	Φ 90 mm, h = 8 mm			
Drying chamber dimensions	120 x 120 x 20 mm			
Net / Gross weight	4,9 / 6,4 kg			
Packaging dimensions	470 x 380 x 336 mm			

Overall dimensions:

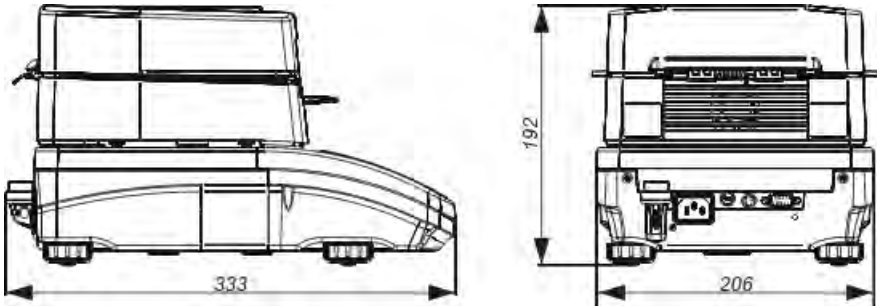

2. GENERAL SAFETY INFORMATION

2.1. Signals and warning signs

Safety precautions are marked with special descriptions and warning signs. They inform and warn a user of possible dangers. Ignoring the safety warnings may cause injuries, damage of the moisture analyzer, its inappropriate operation and errors of measurements.

2.1.1 Warning descriptions

WARNING	Dangerous situations of high risk. These situations can cause serious injuries or death if the safety precautions are not taken.
CAUTION	Dangerous situations of low risk. These situations can cause damage of the instrument or its functions, loss of dataas well as minor or moderate body injuries.
ATTENTION	Important information on the moisture analyser.

2.1.2 Warning signs



Electric shock risk



Acid / Corrosion



Danger



Flammable or explosive substances



Toxic substances



Hot surfaces

2.2. Safety information

CAUTION!

Using moisture analyzer regardless of both, safety information and user manual guidelines may cause health damage and even death.

WARNING:



Nominal voltage for a moisture analyzer is 230 VAC. It means that safety usage precautions for low voltage devices must be abided by while operating the device. Three-core power supply cable with grounding pin comes standard with a moisture analyzer. If necessary, an extension cord can be used as long as it meets the applicable standards and has a protective ground conductor. Intended disconnection of the grounding cable is forbidden.



CAUTION:

Drying chamber cannot be opened during operation (drying process). It is due to the fact that a halogen lamp and its glass shield may reach the temperature of up to 400 C. When setting up the moisture analyzer leave enough space to prevent heat from building up and to keep your analyzer from overheating. Leave about 20 cm around the instrument and about 1 m above. Air vents that are located in the housing cannot be covered, sealed or blocked in any other way. Do not put any flammable substances on, under or near the moisture analyzer. Be particularly careful when removing the sample from the drying chamber: the sample itself, the drying chamber, shields and the pan can still be extremely hot. In case of any maintenance work (cleaning the inside of the drying chamber), the moisture analyzer must be switched off. Wait until all the components have cooled down. Do not perform any modification to the heating module.

Same types of samples require taking particular safety precautions.

They can pose a danger for people and objects. It is always the user who is liable for possible damages caused by the use of an inappropriate sample.



CAUTION:

Corrosion

Substances that release aggressive vapours (e.g. acids) during the heating process. While drying such substances it is recommended to work with small samples. Otherwise, vapours can condense on cold housing parts and cause corrosion.



WARNING:

Fire or explosion

Flammable or explosive substances, substances containing solvents or releasing flammable or explosive gases or vapours. Before carrying out the procedure, perform risk analysis when in doubt relating to the sample characteristics.

For the said type of samples, apply as low drying temperatures as possible, thus preventing flames or explosion. During the analysis it is necessary to wear protective glasses and gloves. The samples should be relatively small.

Under no circumstances can the instrument be left unsupervised!



WARNING:

Substances containing toxic and caustic or corrosive components

Substances that release toxic gases or vapours can cause irritations (eyes, skin or respiratory system), illnesses or even death. Dry such substances only in fume hood.

Under no circumstances should the instrument be used in an area with any risk of explosion. The moisture analyzer is not designed to operate in hazardous areas.

2.3. Intended use

Moisture analyzer is designed to verify relative moisture content in small samples of various substances, dry mass content in small samples and mass of weighed objects. The device ensures fast and precise determination process of water content in a tested sample whereas application of touch screen display considerably simplifies operation and improves functionality of the moisture analyzer. The device can be used to determine humidity content of different materials.

At the initial stage of measurement, the moisture analyzer precisely determines mass of an object placed on a weighing pan. As the mass reading is stabilized, the sample is quickly heated by a halogen lamp, an IR emitter or a metal heater causing humidity evaporation from the tested sample. While sampling, the moisture analyzer is continuously checking loss of mass, and on calculation, it displays current moisture content of a tested sample. Compared to conventional methods of humidity content determination of various substances, application of moisture analyzer considerably shortens measurement time and simplifies testing procedure. Moisture analyzer facilitates setting multiple parameters which influence the procedure of moisture content determination in a sample (temperature, time, drying modes, etc.).

2.4. Inappropriate use

CAUTION!

Do not open the drying chamber during drying process. Moisture analyzer features a halogen lamp which is a very powerful heat source. Thus, user should pay special attention not to touch those elements of a moisture analyzer that get hot while drying procedure (i.e.: disposable pan, pan handle, and inner shields of the drying chamber).

Remember that some tested samples may become dangerous when heated (emission of poisoning vapours, danger of ignition or explosion).

Moisture analyzer is not intended for dynamic weighing. Even if small amounts of a sample are added to or taken off the weighing pan, the mass readout should be taken only on stabilization of measurement result (appearance of stability pictogram  on the display).

Do not place any magnetic materials on the weighing pan, as this can cause damage of the measuring system of the instrument.

Be sure to avoid impact shock and overloading the moisture analyzer in excess of the prescribed maximum measuring range (max capacity), minus any possible tare weight that has been applied).

Never use the moisture analyzer in an environment endangered by an explosion!

This moisture analyzer is not adjusted for operation in explosive areas. It is forbidden to make any modification to the moisture analyzer.

2.5. Principles of safety use

Moisture analyzer is in accord with all binding safety regulations. Nevertheless there are exceptional circumstances that may cause danger.

It is forbidden to open an instrument housing. Inside there are no parts that would require maintenance, repair or replacement carried out by a user. In case of any problems it is recommended to contact RADWAG service or a distributor.

It must be always remembered to use the device in accordance with this user manual and especially to follow instructions on installation and configuration of a new device.

Use of a moisture analyzer conversely to safety principles and user manual guidelines may be hazardous to operator's health and life. It is obligatory to acknowledge the safety principles listed in the user manual:

- use a moisture analyzer only to determine humidity content in samples and determine mass of a tested sample. Any other use of the moisture analyzer may be dangerous both to the device and the user,
- before commissioning the moisture analyzer, make sure that the nominal power of the device specified on its data plate is compatible with the supply in the mains to which the moisture analyzer will be plugged in,
- **change of halogen lamps can only be carried out by authorized service,**
- protect moisture analyzer against contacts with liquids, it might lead to electrocution, fire, emission of substances containing toxic or caustic vapour, emission of explosive substances.

2.6. Warranty

Warranty does not cover the following cases:

- Not observing the regulation listed in user manual,
- Using the moisture analyzer conversely to its intended use,
- Any modifications of moisture analyzer or cases when its housing has been opened (damaged protective stickers),
- Mechanical defects and defects caused by media, liquids, water and natural wearing off,
- Improper placing or defects of electrical network / mains origin,
- Overloading of measuring mechanism.

2.7. Metrological parameters monitoring

Moisture analyzer metrological parameters shall be monitored in specified time intervals. Checks frequency is determined by ambient conditions, performed weighing processes and adopted system for quality monitoring.

2.8. Data included in this user manual

Please read the user manual carefully before plugging the instrument to mains and its startup. Familiarizing the manual is necessary even for users experienced with this type of moisture analyzers.

2.9. Staff competence

Moisture analyzer should only be operated and maintained by personnel who is trained and experienced in using this type of instruments.

In order to use the moisture analyzer, first read the user manual. Keep these instructions for the future reference.

Do not make any structural modifications. Additional equipment, which can be connected to the moisture analyzer, should be supplied by RADWAG or an authorized distributor.

2.9.1. Protective clothing

The use of protective clothing is highly recommended while working with the instrument, this is to take safety precautions against potential hazards, source of which might be tested samples and ingredients.

Use the following while carrying out tests:

- protective apron,
- protective glasses,
- protective gloves (while working with hazardous chemical substances).

Before the use of above-mentioned protective clothing, make sure that it has been designed to be used with specific samples and that it is not damaged.

3. TRANSPORT AND STORAGE

3.1. Delivery check

Please check the packaging immediately upon delivery and check instrument's condition directly upon unpacking for any visible signs of external damage.

3.2. Packaging

Please retain all parts of the original packaging should the moisture analyzer be transported in the future. Only the original packaging should be used for dispatching the moisture analyzer. Before packing, disconnect all attached cables and remove any loose/movable parts (weighing pan, shields, inserts). Place moisture analyzer and its components in their original packaging, and protect them against damage during transport.

4. UNPACKING, ASSEMBLING AND STARTUP

4.1. Assembling and place of use

- A moisture analyzer should be stored and used in locations free of vibrations and shakes, free of air movement and dust, located at the max altitude of 2000 above sea level,
- Moisture analyzer's place of use should ensure good air circulation around the instrument (approximately 20 cm free space around the moisture analyzer and 1 m free space over it),
- Ambient air temperature in the weighing room should not exceed the range of:
 - +10 °C □ +40 °C,
- Ambient relative humidity should not exceed 80% in the temperature up to 31°C, and decrease linearly to 50 % of relative humidity in temperature 40°C,
- A moisture analyzer should be located on a stable wall console desk or a stable working table which is not affected by vibrations and distant from heat sources,
- Take special safety measures when weighing magnetic objects, as part of the balance is a strong magnet.

4.2. Unpacking

Carefully remove the moisture analyzer from its packaging, remove the transport protective elements. Gently place the moisture analyzer in its intended place of use.

Assembly the components of drying chamber, following the below guidelines:

Assembling moisture analyzer components:

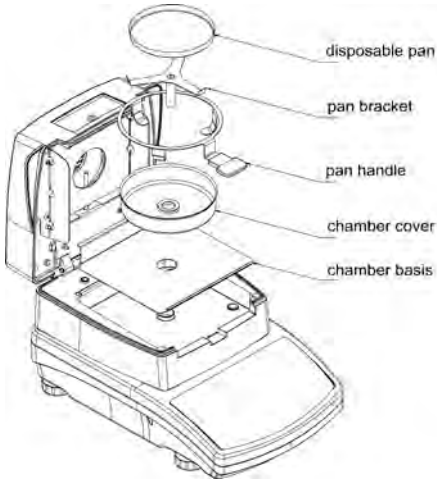

- Assembly insert of the drying chamber's basis
- Assembly drying chamber shield,
- Assembly drying pan handle,
- Assembly drying pan bracket,
- Assembly the disposable drying pan.

Positioning the bracket.

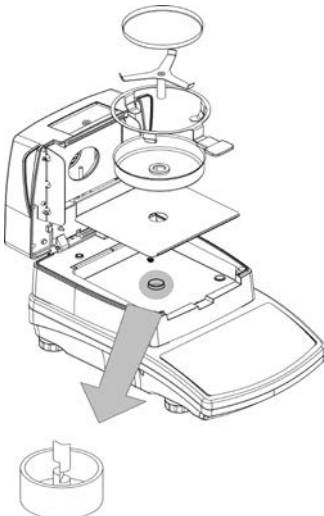

When assembling the pan supporter (bracket) pay special attention to the correct positioning of its mandrel. The mandrel features a cut for its unique positioning against the pan handle, thus preventing their contact and friction.

Setting pan's bracket:

- On assembling the pan bracket onto the mandrel, turn the bracket slightly, so that the cut on the mandrel is located in their unique and correct position,
- When turning the mandrel use most gentle movements not to damage moisture analyzer's measuring system.

4.3. Level setting



Prior plugging the device to mains it is necessary to perform levelling procedure. To level moisture analyzer one shall turn its feet left and right until the air bubble moves to its central position.

4.4. Standard delivery components

- Moisture analyzer.
- Insert for drying chamber basis.
- Drying chamber shield.
- Drying pan handle.
- Drying pan bracket.
- Disposable pan.
- Power cord.
- User manual – CD version.

4.5. Cleaning

Remember to unplug the moisture analyzer from mains before any cleaning activities.

Clean the moisture analyzer using a damp cloth, rub contaminated places gently.

The drying pan and the bracket must be removed from the drying chamber prior cleaning. **Cleaning these parts while installed may lead to instrument's measuring system damage.**

4.6. Plugging to mains

A moisture analyzer can be plugged to mains only by means of an original power cord, which comes standard with the moisture analyzer. Rated voltage (specified on device's data plate) must be compatible with mains rated voltage.

The power cord can be connected only to a socket with ground contact. Plug the power cord to the moisture analyzer. The moisture analyzer's power plug is located at the back of its housing.

Moisture analyzer display shows name and program number first, next indication in a form 0.000 g (balances with readability of 1 mg) or 0.0000 g (balances with readability of 0,1 mg). If the indication does not equal zero, press **O/T** button.

4.7. Connecting peripheral equipment

The moisture analyzer must be unplugged from the mains before connecting or disconnecting any peripheral equipment (printer, PC computer). Use only peripheral equipment recommended by the manufacturer with your moisture analyzer. These have been ideally coordinated to your moisture analyzer. On connecting a peripheral device, plug the moisture analyzer to mains.

5. KEYBOARD

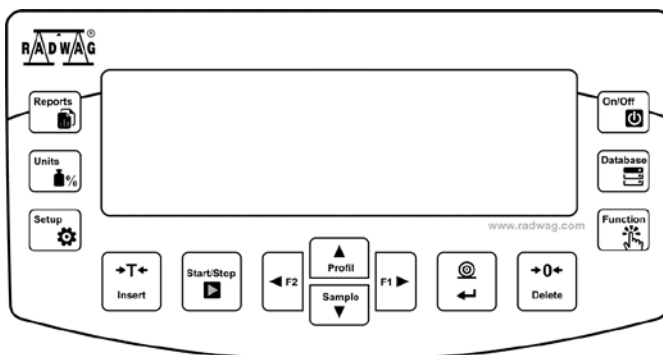

ON/OFF button enables switching on and off balance's display. If switched off, balance components other than the display are powered, and balance is in stand-by mode.
F9 button of the computer keyboard.



Direct access to data stored in a database: user, product, tare, drying mode.
F10 button of the computer keyboard.



Function button enabling quick access to settings of an active working mode.
F11 button of the computer keyboard.



Reports – quick access to drying process reports database.
F5 button of the computer keyboard.



Quick access to drying parameters settings (button active only for moisture analyzer mode)



Quick access to sample database







UNITS button for changing measuring units in course of the drying process: %M, %D, %R, g.



PRINT/ENTER button for sending current display status to a peripheral device (PRINT) or for accepting selected value of a parameter or function (ENTER).



ZERO button – zeroing balance indication.

	TARE button – tarring balance indication.
	Function button for direct running/aborting drying process. <i>F6</i> button of the computer keyboard.
	Function button for entering the main balance menu. <i>F7</i> button of the computer keyboard.
	Navigating arrows for operating balance menu or changing parameter value.

6. START-UP

When plugged to mains, the balance displays program name and number, next it proceeds to the weighing mode.

6.1. Temperature stabilisation period

Before start of measuring processes, it is necessary to wait until the balance reaches thermal stabilization.

For balances that were stored in much lower temperatures before plugging to mains (e.g. during winter period), thermal stabilization period shall take at least 4 hours. During the thermal stabilization, the indications on the display panel can change. Correct operation of a balance is possible within temperature range specified in technical parameters, see point 1.





It is recommended that ambient temperature changes at place of use were insignificant (slow to change).

7. USER MENU

Menu is divided into 6 basic function groups. Each group has individual name starting with capital letter **P**.

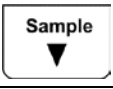
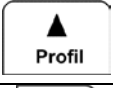
7.1. Operating user menu

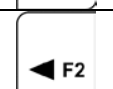
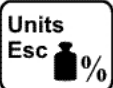
The user operates menu using buttons of overlay keyboard:

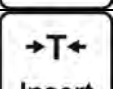
	Setup button. Entering the main menu.
	Selecting group of parameter one by one downwards or changing parameter value by one value down.
	Selecting group of parameters one by one upwards or changing parameter value by one value up.
	Selecting a particular group of parameters for activation. On pressing the button, the display indicates the first parameter of a selected group
	Exit to previous menu level, e.g. to the main menu.
	Abandon parameter changes.
	Accept / confirm introduced changes.
	Deleting a character while editing text values, e.g. user name.
	Inserting a character while editing text values, e.g. user name.

P1 ADJUSTMENT

- P1.1 EXT. CALIB. | [external adjustment]
 - P1.2 USER CALIBRATION | [user adjustment]
 - P1.3 THERM. CAL. | [adjustment of control thermometer]
 - P1.4 TEPPERATURE TEST | [test of control thermometer]
-

P2 WORKING MODE

- P2.1 WEIGHING | [settings for weighing function]
 - P2.2 MOISTURE ANALYZER | [settings for drying function]
-

P3 COMMUNICATION

- P3.1 COM 1 | [transmission parameters for port COM 1]
- P3.2 WIFI | [transmission parameters for port WIFI]

P4 DEVICES

- P4.1 COMPUTER:
 - PORT | COM 1/USB/WIFI/NONE [PC connection port]
 - CONT. TRANSM. | CALIBRATION UNIT./ CURRENT UNIT/ NONE
[turning on/off continuous transmission]
 - INTERVAL | 0.1 [setting intervals for continuous transmission]
 - E2R SYSTEM | YES/ NO [turning on/off cooperation with E2R system]
 - PRINTOUT | [printout type for print to computer function]
 - P4.2 PRINTER | COM 1/USB/WIFI/PENDRIVE/USB PC/NONE [printer connection port]
 - P4.3 BARCODE READER | COM 1/NONE [barcode reader connection port]
-

P5 PRINTOUTS

- P5.1 CAL. REPORT | [contents of the adjustment report]
 - P5.2 HEADER | [contents of the header printout]
 - P5.3 GLP PRNT. | [contents of the weightment result prnt.]
 - P5.4 FOOTER | [contents of the footer printout]
 - P5.5 DRYING PROCESS PERORT | HEADER, MEASUREMENT, FOOTER
 - P5.6 NSD.PRN.1 | [project of non-standard printout 1]
 - P5.7 NSD.PRN. 2 | [project of non-standard printout 2]
 - P5.8 NSD.PRN. 3 | [project of non-standard printout 3]
 - P5.9 NSD.PRN. 4 | [project of non-standard printout 4]
 - P5.10 VARIABLE 1 | [project of variable 1]
 - P5.101VARIABLE 2 | [project of variable 2]
-

P6 OTHER

P6.1 LANGUAGE	POLISH / ENGLISH	[menu language]
P6.2 ACCESS LEV.	ADMIN	[access levels for editing menu]
P6.3 KEY SOUND	YES/NO	[key sound]
P6.4 BACKLIGHT	70	[display backlight level]
P6.5 SLEEP MODE	NONE/0.5/1/2/3/5	[backlight turn-off time interval]
P6.6 AUTO SWITCH-OFF	NONE/1/2/3/5/10	[display turn-off time interval]
P6.7 DATE	2013.05.27	[data settings]
P6.8 TIME	8:53:00 A	[time settings]
P6.9 DATE.FORM.	YYYY.MM.DD/YYYY.DD.MM/DD.MM.YYYY/MM.DD.YYY	[date format]
P6.10 TIME FORM.	12H/24H	[time format]

P7 INFO

P7.1 BALANCE ID	123456
P7.2 SCALE TYPE	AS
P7.3 SOFT. VER.	1.x.x
P7.4 TEMP.	21.7 °C
P7.5 CHAMB. TEMP.	30.5 °C
P7.6 SETUP PRNT.	[balance parameters printout]

7.2. Return to weighing mode







CAUTION

*Balance memory modifications will be saved upon abandoning the menu (on return to weighing).
Press ESC button several Times.*

8. LOGGING IN

In order to have full access to user parameters and be enabled to edit databases, the balance operator should log in as <ADMINISTRATOR> each time running the balance. The software enables the entry of 10 users with various access rights.

The first login procedure

- While in the main window select <LOG IN> option available by pressing  button or by pressing one of the function buttons to which the shortcut <LOG IN> is assigned, you can also press the  button, enter users database and select <ADMIN> user
- After selecting the <ADMIN> user and confirming the choice by pressing , you will be asked to enter the user's password,
- Enter „1111” and confirm by pressing ,
- The program returns to the main window,
- After the first logging, enter users and assign the appropriate access levels to them (*see section 14 for detailed instruction*).

On successive logging in, select a user from the list and enter a respective password. The program is run with access level of the selected user.



If any user is logged in, a pictogram  is displayed.

Logout procedure

- In order to log out, select <NONE> position out of the list of available users
- The program returns to the main window, and the display shows no logged-in user. (no logged-in user, no pictogram on the display).

Access levels

The balance software features three access levels: ADMINISTRATOR, ADVANCED, USER.

When you turn the balance on, the display is active all the time, which enables carrying out mass measuring processes.

The table below presents access rights to user parameters editing, databases and software functions depending on the access level.

Access	Access levels
USER	Access to editing submenu parameters: <Reading> and settings of parameter group <Other> except for <Date and Time>. Any weighing process can be started and carried out. The user has the access to information preview function in <Databases>, he/she can define universal variables.
ADV	Access to editing submenu parameters: <Reading>; <Working modes>; <Communication>; <Devices>; <Others> except for <Date and Time>. Any weighing process can be started and carried out.
ADMIN	Access to all user parameters and functions, editing databases enabled.

9. WEIGHING

Moisture analyzer offers two weighing modes. The first, <WEIGHING>, used for determining weight of measured loads, the second, <MOISTURE ANALYZER>, used for determining humidity content of a tested sample. This part of manual informs on how to use the device as scales, ie. how to operate <WEIGHING> mode. Some options and settings are similar for both modes therefore detailed description for their usage and settings is to be found in this section. Section overviewing <MOISTURE ANALYZER> mode describes specific settings enabled for moisture analyzer.

9.1. Required weighing procedures

In order to ensure long lasting use of a balance and reliable measurement of weighed loads, follow below procedures:

- Start the balance with no load on a weighing pan
(permissible value of load on the weighing pan on balance start is $\pm 10\%$ of its maximal capacity).
- Load balance's weighing pan steadily with no shocks:

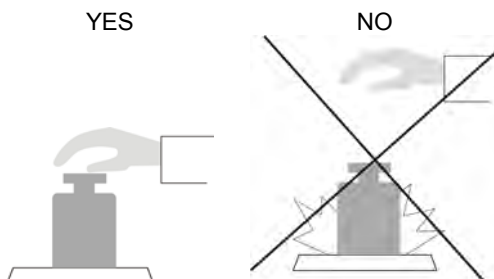

- Place weighed loads centrally on the weighing pan:



- Avoid side loading, in particular side shocks:

NO NO

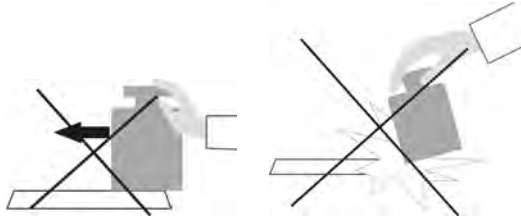

The balance requires adjusting before running the weighing process or in case of drastic change of ambient conditions at a workstation (e.g. ambient temperature change at a workstation more than 3°C). The procedure of balance adjustment is described further down this user manual.

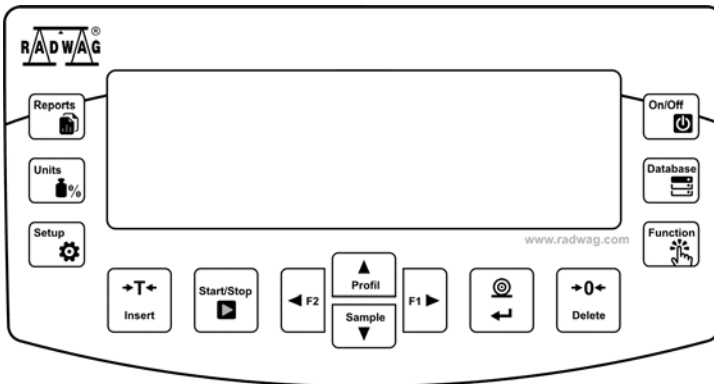

- Before the start of weighing procedure, it is recommended to load the weighing pan a few times with mass close to balance max capacity,
- Check if unloaded balance indicates “precise zero” and whether measurement is stable, if not, press **→0←/Delete** button,
- Place weighed object on the weighing pan and read result only on measurement result stabilization,
- Mass indication of a load placed on the weighing pan can be tarred multiple number of times by pressing **→T←/Insert** (pay CAUTION not to exceed maximal capacity of a balance by applying multiple tare function).



The balance shall stay plugged to mains in between measurement series. It is recommended to switch off the balance display by pressing **ON/OFF** button. On repeated **ON/OFF** button pressing, the balance is ready for operation and carrying out the following measurements.

9.2. Zeroing



In order to zero mass indication press  button. Mass indication of zero value shall be displayed together with precise zero $\rightarrow 0 \leftarrow$ and stability .

Zeroing process is an equivalent for determining new zero point, recognized by the balance as precise zero. Zeroing is possible only for stable status of display indication.



Caution:

Zeroing the display indication is possible only within the $\pm 2\%$ range of instrument's maximal capacity. If the zeroed value is above the $\pm 2\%$ of the maximal capacity, then the software indicates an error message **Err2**.

9.3. Tarring

In order to determine the net weight of a weighed object, place object's container (packaging) on the weighing pan, and on stabilization of measurement



result press  button. The display should indicate mass equal to zero and symbols: **Net** and .

On taking off the weighed load and its packaging from the weighing pan, the display indicates sum of total tarred mass with minus sign.

The software also enables assigning tare value to a product from a database. Then, on product selection from a database, the software automatically uploads data on tare value for the specific product.

Caution:

Tarring negative values is impossible. On tarring negative values the balance responds with an error message Err3. In such case perform zeroing and repeat tarring procedure.

Manual tare determination

Procedure:

- While in optional mode, press quick access button **F**, to which the option **<ENTER TARE>** has been assigned in **<SHORTCUTS>** settings (*setup instruction to be found further down this user manual, point <F button shortcuts>*),
- Wait for a respective window to open,
- use the arrow buttons to enter tare value and press  button,
- the balance returns to weighing mode, and the display indicates entered tare value with minus „-“ sign.

Selecting tare out of TARE DATABASE

Procedure:

- While in optional mode, press quick access button **F**, to which the option **<SELECT TARE>** has been assigned in **<SHORTCUTS>** settings (*setup instruction to be found further down this user manual, point <F button shortcuts>*), or click **<SELECT TARE>** option available



upon pressing button,

- wait for the first packaging weight, recorded in tare database, to be displayed,
- use the arrow buttons to select the tare which is to be recalled and



press button,

- the balance returns to the weighing mode, and the display indicates entered tare value with minus „-“ sign.

or



- While in any working mode, press button,
- Enter b3 **<TARE>** option,
- Wait for the first packaging weight, recorded in tare database, to be displayed,
- use the arrow buttons to select the tare which is to be recalled and



press button,

- the balance returns to the weighing mode, and the display indicates entered tare value with minus „-“ sign.

AUTOTARE

Function allowing for automatic taring of the packaging during the weighing process when packaging mass for each of the product is different. Description of this function is to be found further down this manual.

Deleting tare



Entered tare value can be deleted by pressing button of the balance's overlay or by entering tare value of 0.000g (see description above).

9.4. <WEIGHING> mode settings

The software allows setup of operating parameters (filters, value release and autozero option, deleting the last digit and other settings) separately for each working mode.

It enables customising the instrument and utilising its properties depending on the user's needs and expectations, or on specific requirements for selected working mode (e.g. DOSING); as a result the device operation is quick and easy.

Available settings:

P2.1.1 – READING

P2.1.1.1 – FILTER [V.FAST/ FAST / NORMAL / SLOW / V. SLOW]

P2.1.1.2 – RESULT ACC. [REL. / FAST / FAST+REL.]

P2.1.1.3 – AUTOZERO [YES / NO]

P2.1.1.4 – LAST DIGIT [ALWAYS / NEVER / WHEN STAB.]

P2.1.1.5 – ENVIRON (STABLE/UNSTABLE)

P2.1.2 – AUTOTARE [YES / NO]

P2.1.3 – PRINT MOD

P2.1.3.1 – MODE [EACH / WHEN STAB. / AUTO]

P2.1.3.2 – AUTO. THRES

P2.1.4 – INFORM. [TARE / NETTO / GROSS / USER / PRODUCT / /NSTD. INF. / NONE]

P2.1.5 – INF. NSTD. (non-standard information – any text, max 19 characters)

P2.1.6 – HOT KEYS (available options depending on the working mode)

P2.2.6.1 – F1 [NONE / ENTER TARE/ ...]

P2.2.6.2 – F2 [NONE / ENTER TARE / ...]

9.4.1. Filter level setting

Filter shall be set depending on the ambient and environment conditions. For the best possible conditions the filter can work in a very fast mode (V.FAST value for parameter P.2.2.1.1 Filter); however, if the conditions are bad (shakes, drafts), the filter should be set to slow or very slow option (SLOW or V. SLOW value for parameter P.2.2.1.1 Filter). The effectiveness of the filter is different for the weighing range. The filter works slower when “approaching” the weighed mass, it works more intensively for weighed mass within the set range of the filter (parameter for setting filter range is accessible only from the service menu – the user does not have an access to it).

Depending on the filter, the weighing time is shorter (V.FAST and FAST) or longer (SLOW and V. SLOW).

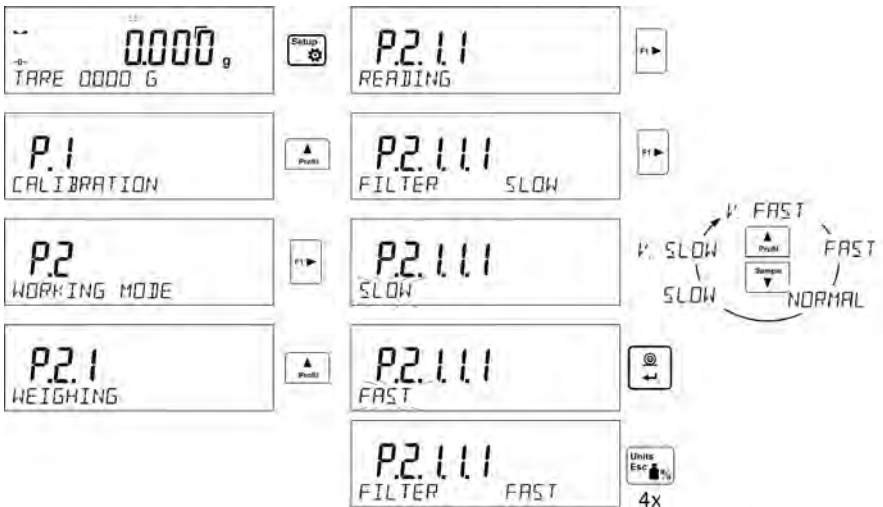

CAUTION

The higher filter level, the longer weighing time.

9.4.2. Value release

Since ambient conditions at a workplace vary it is necessary to determine the value release parameter in a most preferable way enabling balance adaptation, parameter options are: **FAST.+REL.**, **FAST** or **RELIABLE**. Depending on selected option, weighing time is either shorter or longer.

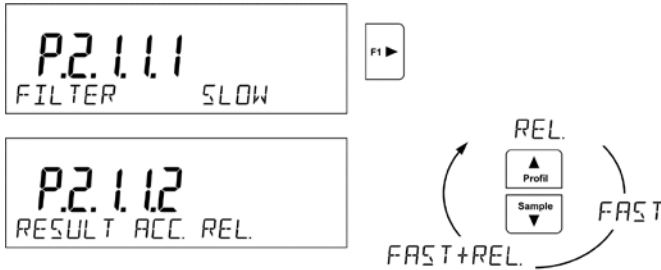

9.4.3. Autozero function

The software features autozero function (**Auto**) ensuring precise mass indication. This function automatically controls and corrects zero indication. When Autozero is enabled, it compares balance indications at declared time interval e.g. 1s, providing that weighing pan is unloaded and display indication is close to zero. If results vary less than declared AUTOZERO range e.g. one division, balance zeros automatically, marker of stable measurement result –  and precise zero marker – **0** – are displayed.

If AUTOZERO function is enabled, then each weighing process starts from precise zero point. There are, however, some cases when this function can be a disturbing factor for the measuring process; e.g. very slow placing of load on the weighing pan (load pouring). Here, zero indication correction can also correct actual indication of loaded mass.

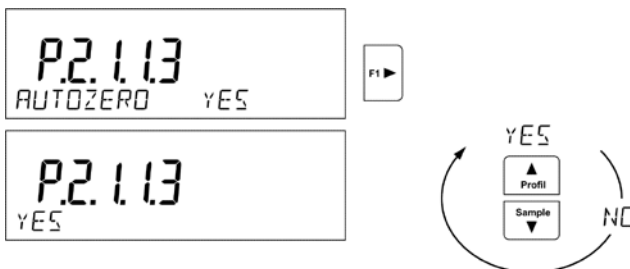

9.4.4. Displaying the last digit

Function enables displaying the last digit on a balance display.

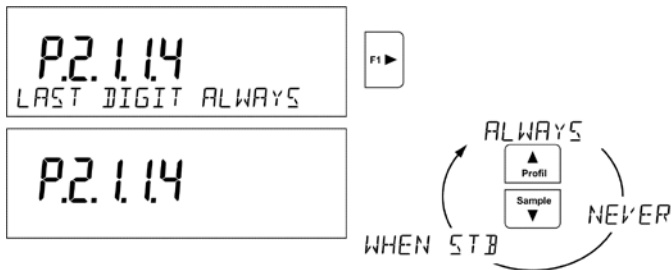

9.4.5. Ambient and environmental conditions

This parameter has two settings: STABLE and UNSTABLE. Selecting STABLE mode makes the balance work much faster, i.e. weighing takes much less time than for UNSABLE mode. This parameter relates to ambient and environmental conditions in which the balance operates. If the ambient conditions are unstable it is recommended to use UNSTABLE mode. Normally the parameter is set to STABLE option.

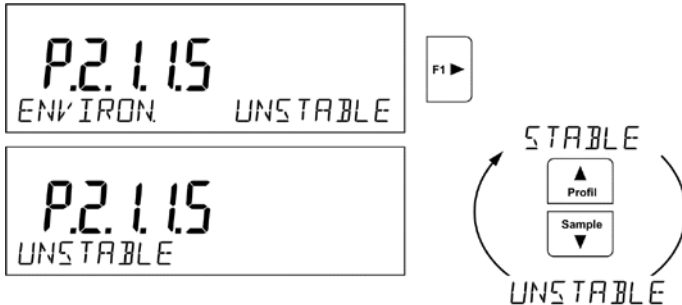

9.5. AUTOTARE

In case of loads with different tare values being weighed one after another automatic tare function is useful for quick determination of the weighed loads net mass.

When function is active (<P2.2.2 AUTOTARE> value set to <YES>), the operating process is as follows:

- Make sure that the weighing pan is empty and press button responsible for zeroing,
- Put product packaging on a weighing pan,

- After measurement stabilization **automatic taring** of the packaging mass will proceed (**Net** marker appears in the upper part of the display),
- Put product that is to be packed on the packaging;
- Display will show a net mass of the product;
- Take off the product together with the packaging;
- The balance cancels tare value (packaging weight saved in balance storage during the first step of the operating process) after the gross mass value (set in < **P 2.2.3.2 AUTO THRES**> parameter) has been exceeded;
- Put packaging of a next product on a weighing pan, after measurement stabilization automatic taring of the packaging weight proceeds (**Net** marker appears in the upper part of the display);
- Put a next product that is to be packed.

For a correct operation of the balance with AUTOTARE function, the threshold value must be adjusted.



<**P 2.2.3.2 AUTO THRES**> parameter is connected with the following functions:

- automatic tare,
- automatic operation,

There will be no automatic taring until the balance operates within the gross mass value range set in < **P 2.2.3.2 AUTO THRES** > parameter.

9.6. Printing mode

This function enables setting the printing mode, i.e.  button activity.

A user has the possibility of selecting the following settings:

- <WHEN STAB> the stable measurement result, along with the settings for parameter <GLP PRINTOUT> are sent to the printer port. On pressing



button, when the result is not stable (no  sign on a display), the balance software will send the measurement result to the port after reaching stability for the measurement.



- <EACH> every single pressing of  button results in sending the measurement result to the printer port along with the settings for parameter <GLP PRINTOUT>. Every measurement result is sent (stable and unstable). The <?> sign appears at the beginning of the printing frame when the result is unstable.

This function applies only to non-verified balances.

- <AUTO> - select this option to enable automatic printing of measurements. If this option has been selected, remember to select <AUTO THRES > parameter to suit your needs.

Automatic operation procedure:



- Press  button to zero the balance (marker of stable measurement  and zero marker  are shown on a display)
- Deposit load, the balance sends the first stable measurement to the printer port,
- Remove the load from the balance,
- Next measurement is possible when the indication is lower than the set value of <AUTO THRES.> parameter (next measurement does not require zero value).

Procedure for settings modification:

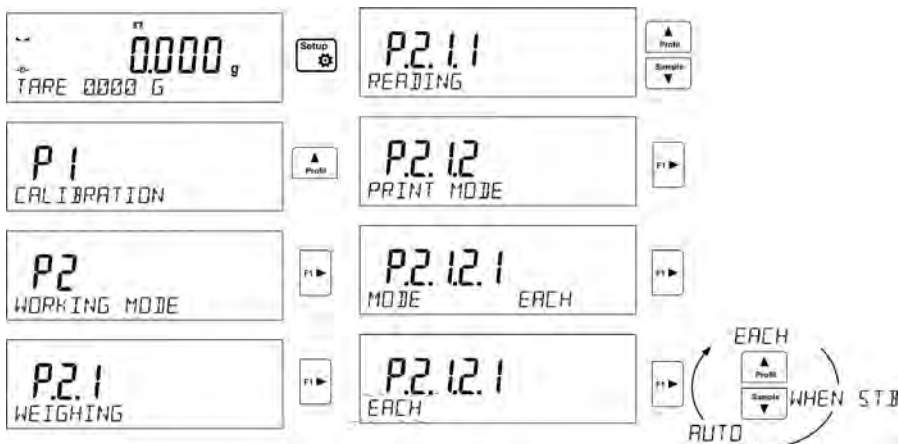

For automatic working mode adjust the threshold value.



< AUTO THRES. > parameter is connected with the following functions:

- automatic tare,
- automatic operation,

For automatic operation function the measurement will not be send from the computer to the printer as long as the mass measurement stays within the set value range < P 2.2.3.2 PROG THRES>.

9.7. Information

Function enables displaying additional information in the bottom line. Depending on the needs, a user can choose the following options, which are shown while working in <WEIGHING> mode:

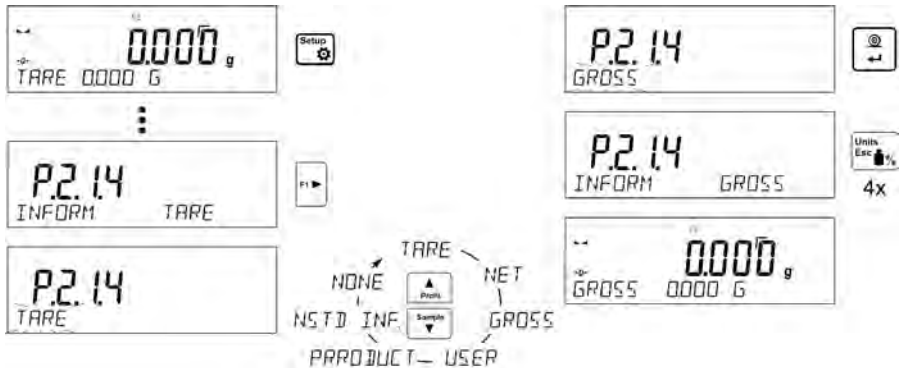

9.8. Non-standard information

Function enables declaring non-standard information, which is to be displayed in the bottom line of the display. A user can insert any text consisting of maximum 19 characters.

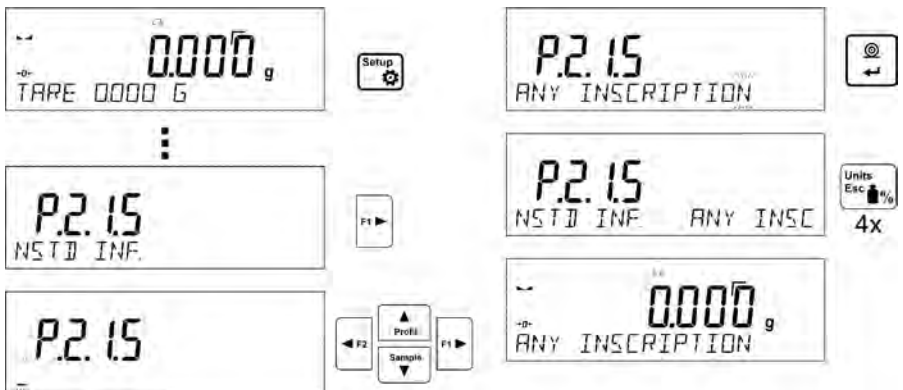

It should be remembered that if the declared non-standard information is to be visible, parameter **P2.1.2** should be set to < **NSTD. INF.** > option.

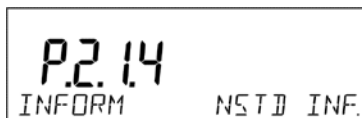

9.9. F button shortcuts

Function enables assigning quick access for weighing functions which are to be accessible by pressing F1, F2, F3 or F4 keys. A user can choose between the following options for <WEIGHING> mode: <NONE / ENTER TARE / PRINT HEADER / PRINT FOOTER / VARIABLE 1 / VARIABLE 2>. These options can be freely assigned to any of the F buttons. For other modes there are more available options (see further sections of this manual).

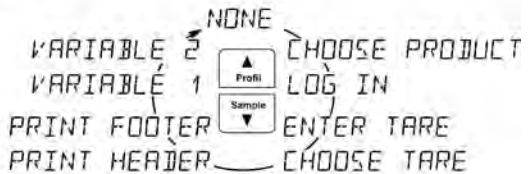

10. OTHER PARAMETERS

A user can set up parameters which influence balance operation. These parameters are to be found in in parameters group **P6 OTHER**.

Settings modification for particular parameters of this parameter group proceeds likewise as described in the previous section.

P6 OTHER

P6.1 LANGUAGE	POLISH / ...	[menu languages]
P6.2 ACCESS LEV.	ADMIN	[access levels for editing menu]
P6.3 KEY SOUND.	YES/NO	[key sound]
P6.4 BACKLIGHT	70	[display backlight level]
P6.5 BACKLIT OFF	NONE/0.5/1/2/3/5	[backlight turn-off time interval]
P6.6 AUTO OFF	NONE/1/2/3/5/10	[display turn-off time interval]
P6.7 DATE	2013.05.27	[date settings]
P6.8 TIME	8:53:00 A	[time settings]
P6.9 DATE FORM.	YYYY.MM.DD / YYYY.DD.MM / DD.MM.YYYY / MM.DD.YYYY	[date format]
P6.10 TIME FORM.	12H / 24H	[time format]
P6.11 GLP AUTOTEST		[carrying out autotest for the balance]

Enter **P6 OTHER** parameters group menu.

10.1. Available menu languages

Parameter which enables selecting the language of the balance menu descriptions. Available languages: POLISH, ENGLISH, GERMAN, SPANISH, FRENCH, TURKISH, CZECH, ITALIAN, HUNGARIAN.

10.2. Access levels

Parameter which enables choosing access levels when entering the balance menu. Available access levels: ADMIN. / USER. / ADV.

Depending on the option selected, a user of a specific access level can access and make changes to the settings in the balance.

10.3. „Beep” sound – response to pressing function button

Parameter which enables switching on/ switching off the ‘beep’ sound responsible for informing a user about pressing any key of balance overlay.

- NO** - ‘beep’ sound switched off
- YES** - ‘beep’ sound switched on.

10.4. Backlight and adjusting display brightness

Parameter which enables setting the brightness of the backlight or switching off the display brightness completely.

- 100** - maximum brightness of the backlight
- 10** - minimum brightness of the backlight
- NONE** - display brightness switched off

10.5. Backlight turn-off time

Parameter <P6.5 BACKLIT OFF> enables use of function responsible for activation of the display stand-by mode when weighing process is not being performed (stable indication is a necessary condition for activation of the stand-by mode).

- NONE** – backlit turn-off time not activated
- 0.5; 1; 2; 3; 5** – time given in minutes

If the software registers stable indication for a specified time interval, parameter <P6.5 BACKLIT OFF> settings, than the display backlit function is turned-off immediately.

The backlit function is turned on upon change of indication (no stability pictogram on the display) or pressing any key on the balance keypad. Backlit turn-off time functions when balance menu is operated.

10.6. Auto switch-off

Parameter <P6.6 AUTO OFF> enables use of function responsible for automatic display deactivation (functions as button ). Upon display deactivation the other subassemblies are powered and the balance turns to stand-by mode.

- NONE** – auto switch-off not activated
- 0.5; 1; 2; 3; 5** – time given in minutes

If the software registers stable indication for a specified time interval, parameter <P6.6 AUTO OFF> settings, than the display is turned-off immediately (inactive backlit function, no indication on the display, clock displayed).

To start-up the balance it is necessary to press button  located on the balance keypad. The balance will automatically return to weighing. Balance cannot be turned off if any process is started or if balance menu is entered.

10.7. Date

Parameter which enables setting the current date.

Procedure:



10.8. Time

Parameter which enables setting the current time.

Procedure:



10.9. Date format

Parameter which enables altering the date format on the printout [YYYY.MM.DD / YYYY.DD.MM / DD.MM.YYYY / MM.DD.YYYY]

Where:

YYYY – year

MM – month

DD – day

10.10. Time format

Enables choosing the time format on the printout [12H / 24H].

For the value [12H], in parameter **P6.6 TIME**, letters <A> or <P> will be displayed next to the time value.



Where:

A stands for hours before noon, **P** stands for hours after noon.

Letters **AM** or **PM** are printed out next to the time value.

11. INFORMATION ON BALANCE

This menu includes information about the balance and its installed software. The parameters are strictly informative.

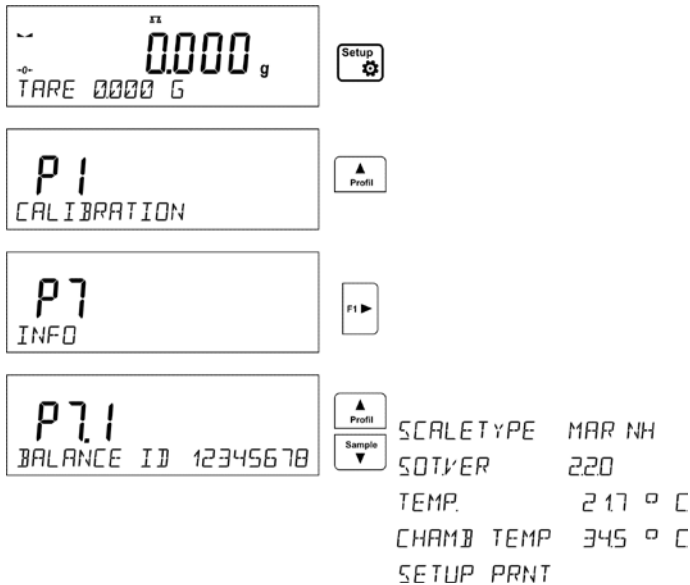

Once the parameter <PRINT. SET> is chosen, the balance settings are sent to the printer (all parameters). The parameters are transferred via port that was chosen for <PRINTERS>.

12. BALANCE ADJUSTMENT

In order to ensure the highest weighing accuracy, it is recommended to periodically introduce a corrective factor of indications to balance memory, the said factor must be referred to a mass standard. In other words, balance adjustment shall be performed from time to time.

Drying process does not require mass adjustment since while counting humidity content for a sample, difference between initial weight and temporarily displayed weigh is taken for calculation.

Adjustment should be carried out:

- Before the beginning of weighing procedure,
- If long breaks between following measuring series occur,

Types of adjustment:

- Adjustment performed by means of external adjustment weight
 - * of declared mass, which cannot be modified
 - * of mass within balance range, freely chosen but not lower than 30% of Max range.



Caution

*In case of verified balances (with internal automatic adjustment system) only the automatic internal adjustment and manual internal adjustment system are available for a user. Remember to carry out the adjustment process when there is no load on the pan! In case there is load on the weighing pan, the display will indicate a command **<RANGE EXCEEDED>**. In such a case the load should be removed from the weighing pan and the process of the adjustment should be finished. Adjustment process can be aborted if necessary by pressing **Esc** at any time during the process.*

12.1. Adjustment menu settings

P1 CALIBRATION

P1.1 EXT. CALIB.		[external adjustment]
P1.2 USER CALIBRATION		[user adjustment]
P1.3 THERM. CAL.		[drying temperature adjustment]
P1.4 TEMPERATURE. TEST.		[drying temperature test]

- **P1.1 EXT. CALIB. - External adjustment (with an external weight)**

Adjustment with an external weight, value of which is saved in factory settings, function unavailable for verified balances.



CAUTION

Function unavailable for verified balances.

- **P1.2 USER CALIB. - User adjustment (with an external weight)**

Adjustment with an external weight of any mass within balance range, however not lower than 30% of Max range.



CAUTION

Function unavailable for verified balances.

12.2. Manual adjustment

12.2.1. Internal adjustment

External adjustment shall be carried out by means of an external weight of class F₁.

Run external adjustment,

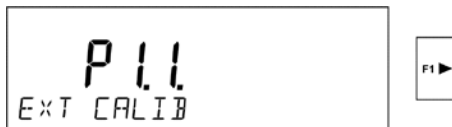

Balance will display a command ordering unloading of weighing pan **<REMOVE MASS>** (weighing pan must be empty). When weighing pan is



unloaded, press button.

The balance determines mass of an empty pan, message **<CALIBRATION>** is displayed in the bottom line. It is followed by message **<PLACE MASS>**. In

the main window the mass value to be placed on the weighing pan is displayed, e.g. **200.000g** (depending on the type of balance). Place an



external adjustment weight of displayed mass and press button. The balance determines the mass, message **<CALIBRATION>** is displayed in the bottom line. On completing adjustment process the balance returns to submenu **P1.1 EXT.CALIB.**



If a balance is verified, it is not possible for a user to carry out external adjustment process.

12.2.2. User adjustment

User adjustment shall be carried out by means of an external weight of class F_1 .

Run external adjustment,



The first step of the process is to declare the mass of a weight that is to be used for adjustment. The mass must be $\geq 30\%$ Max capacity.



Once the mass of the weight is entered and confirmed, the message asking the user to remove the weight from the pan is displayed: **<REMOVE MASS>**



(weighing pan must be empty). After following the instruction press button, the balance shall determine the weight of unloaded pan, message **<CALIBRATION>** is shown in the bottom line.

It is followed by message **<PLACE MASS>**. In the main window the mass value to be placed on the weighing pan is displayed, e.g. **200.000g** (depending on the type of balance).



Place weight of displayed mass and press button. The balance determines the mass, message **<CALIBRATION>** is displayed in the bottom

line. On completing adjustment process the balance returns to submenu **P1.2 USER CALIB.**



If a balance is verified, it is not possible for a user to carry out external adjustment process.

12.3. Adjustment report printout

At the end of each adjustment process or adjustment test, an adjustment report is generated automatically and sent to communication port COM 1. The content of the report is declared in menu P5.1 CAL REPORT.

The description on how to declare settings for this option is described in section about printouts.

The report can be printed out via a printer connected to the balance or it can be sent to the computer and saved as a file for archiving.

12.4. Temperature adjustment (P1.3 THERM CAL)

Temperature adjustment is carried out by means of a dedicated kit, that is an optional equipment of the moisture analyzer.

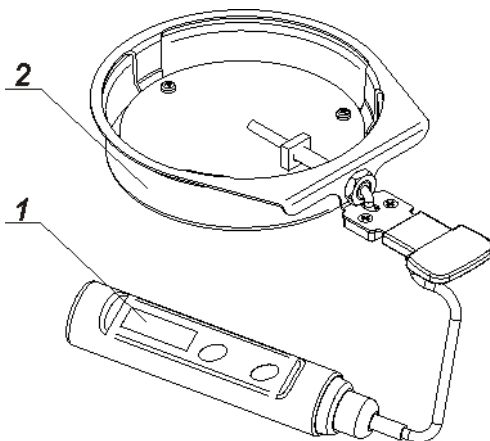

1. Thermometer
2. Thermometer holder and drying chamber shield

Adjustment of the drying chamber temperature is a process carried out for the purpose of adjusting the temperature sensor assembled inside the drying chamber of a moisture analyzer. Before starting temperature adjustment process, place the temperature calibration kit inside the drying chamber, following below diagrams.

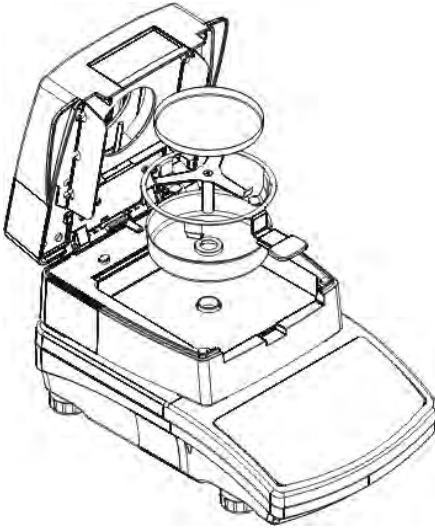

Step 1.

Remove the following components:

- disposable drying pan
- drying pan handle
- drying pan bracket
- drying chamber shield

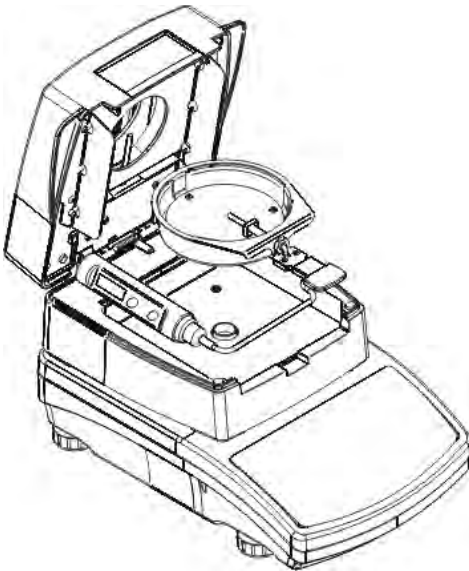

Step 2.

Inside the drying chamber assemble the temperature adjustment kit components:

- drying chamber shield
- thermometer holder and the thermometer

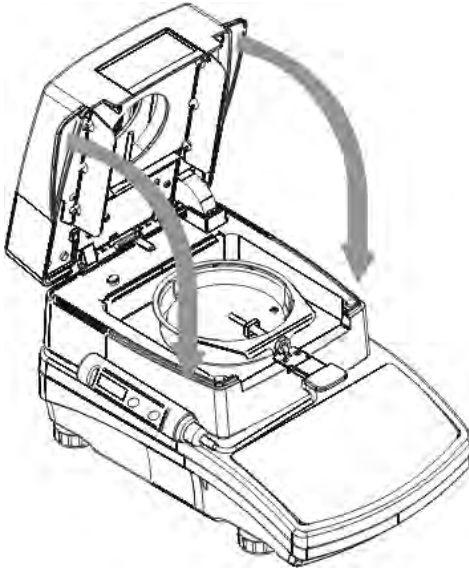

Step 3.

After assembling the kit, close the drying chamber and start temperature adjustment process.

CAUTION:

All the activities must be carried out with great caution so as not to damage the measuring mechanism of the moisture analyzer.

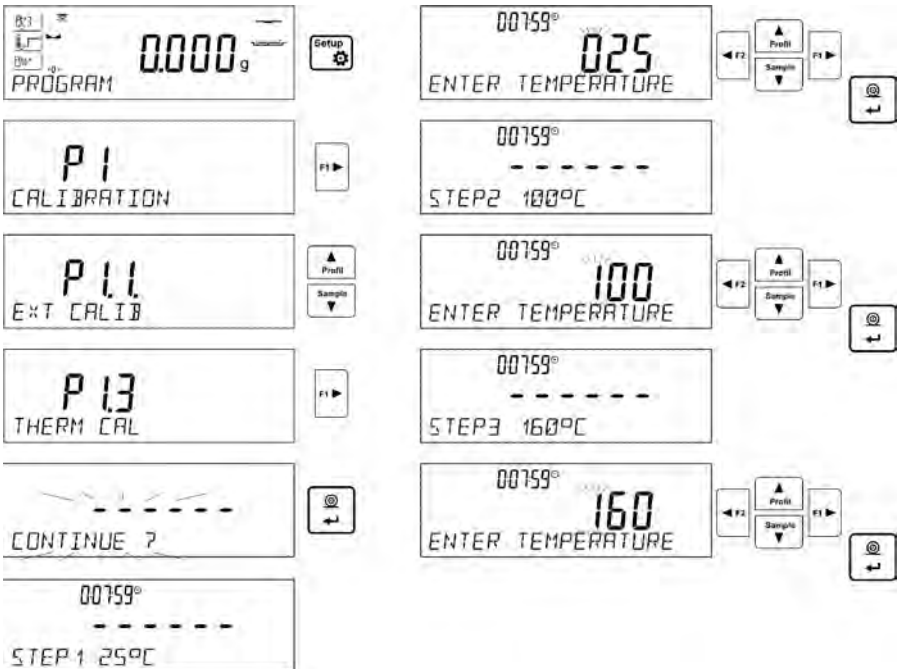

Go to menu <**P1.3 THERM CAL.**>, a message <**Continue?**> shall be displayed, upon confirmation, temperature sensor adjustment starts.

After 8 minutes the display indicates (pulsating) temperature value. Use navigating keys (up and down arrow) of moisture analyzer's overlay to set temperature value to be equal to the current temperature displayed on the control thermometer. Use **Print/Enter** key to start part two of temperature adjustment process. The moisture analyzer runs the halogen lamp and heats the drying chamber to a defined temperature value. The temperature value is maintained for 8 minutes.

After 8 minutes the display indicates (pulsating) temperature value. Like before, use navigating keys to set temperature value to be equal to the current temperature displayed on the control thermometer. On entering the temperature value and accepting it by pressing **Print/Enter** key, the software starts the last part of temperature adjustment process.

The moisture analyzer heats the drying chamber to another temperature value, which is maintained for 8 minutes. After 8 minutes the display indicates pulsating temperature value, which should be changed to be equal to the one indicated on the control thermometer (as previously). On entering temperature value, accept it by pressing **Print/Enter** key. Temperature adjustment process is completed, and the display indicates name of the parameter: < **P1.3 THERM CAL.**>.

For moisture analyzers with maximum heating temperature of 250 °C, the temperature adjustment process is likewise, only the temperature values are higher for each part of the process.



Return to weighing mode

(instruction to be found in section 7.2 – Return to weighing mode).

12.5. Drying process test (P1.4 TEMPERATURE TEST)

<TEMPERATURE TEST> parameter allows to control correctness of thermometer indications. Willing to perform test procedure of the drying chamber and the drying process, the user needs to use a special adjustment set (thermometer and thermometer holder). The set is an optional accessory of a moisture analyser (the same that is used for temperature adjustment of the drying chamber). For assembly instruction of the set go to *Temperature adjustment section*.

To start the procedure, first assembly the adjustment set into the drying chamber, next enter <CAL> menu and run the process <P1.4 TEMPERATURE TEST>, follow the instruction below.

After the thermometer has been assembled, close the drying chamber and proceed to the test.

Enter **P1 CAL** menu, next run <P1.4 TEMPERATURE TEST> procedure. Before the test activation, set its parameters in accordance with diagram and description to be found below.

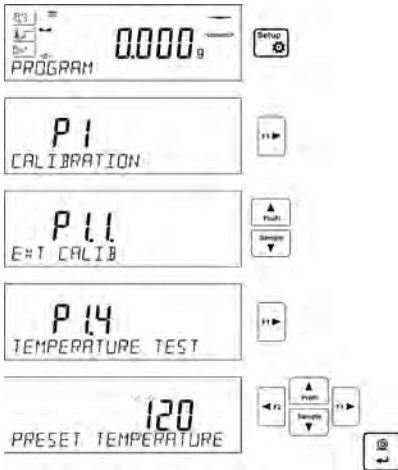

Use navigating arrows to set specified test temperature, press ENTER to confirm.



Enter permissible temperature errors, user approved. Use navigating arrows to enter the specified error, press ENTER to confirm.



Next enter serial number of the adjustment set, which will be used for the test. Use navigating arrows to set the number, press ENTER to confirm.

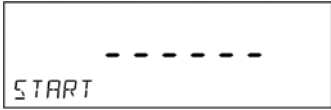

Upon confirmation of the set number, START message will be displayed and the drying process starts upon confirmation by pressing ENTER. The process continues until the specified temperature is reached. Time and sensor temperature information is displayed. The temperature is maintained for 8 minutes (like for temperature adjustment procedure)

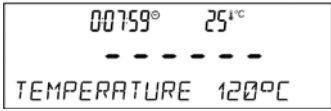

After 8 minutes the user will see a window, where temperature read from the assembled adjustment set must be entered. Use navigating arrows to set the temperature, press ENTER to confirm.

-----Temperature test-----	
User	ADMIN
Date	02.01.2000
Time	4:53:16
Scale Type	MAR_NP
Balance ID	12345678
Temp. cal. Set. no.	721
Preset temperature	120°C
End temperature	120°C
Measured temperature	119°C
Permissible error	+/- 3°C
Status	OK

Signature	

The result of the test may be printed on a printer connected to the balance. Look left to see an example of a report.

13. DETERMINING PRINTOUT CONTENT

13.1. Adjustment report

P5.1 CAL. REPORT, is a group of parameters enabling user to declare data that is to be printed on an adjustment printout.

The settings are valid only for process of mass adjustment.

P5.1 CAL.REPORT

P5.1.1	PROJECT		
P5.1.2	CALIB. TYPE		YES
P5.1.3	USER		YES
P5.1.4	PROJECT		YES
P5.1.5	DATE		YES
P5.1.6	TIME		YES
P5.1.7	BALANCE ID		YES
P5.1.8	CAL.DIFFER.		YES
P5.1.9	DASHES		YES
P5.1.10	SIGNATURE		YES

- **P5.1.1 PROJECT**

Option enables entering the name of a project (e.g. associated with a specific type of weighment). The name can consist of up to 16 characters.

An example project name entered into the balance in capital letters is presented below:

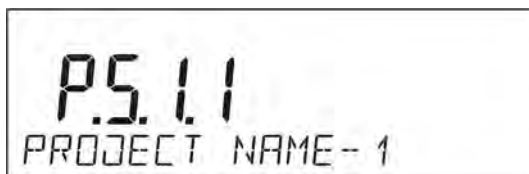

- **P5.1.2 CALIB. TYPE**

Enables printing out the type of the adjustment being carried out.

- **P5.1.3 USER**

Enables printing out the name of logged-in user.

- **P5.1.4 PROJECT**

Enables printing out the name of the project. (see parameter P5.0.1)

- **P5.1.5 DATE**

Enables printing out the date of the carried out adjustment.

- **P5.1.6 TIME**

Enables printing out the time of the carried out adjustment.

- **P5.1.7 BALANCE ID**

Enables printing out the balance ID number.

- **P5.1.8 CAL. DIFFER.**

Enables printing out the difference between the mass of an adjustment weight measured during the last adjustment and the current measured mass of this weight.

- **P5.1.9 DASHES**

Enables printing out the dashes that separate the date of printout from the signature.

- **P5.1.10 SIGNATURE**

Opcja pozwalająca na wydrukowanie pola na podpis osoby wykonującej kalibrację.

Choose one of the options for the above-mentioned parameters.

NO - do not print on the report

YES - print on the report

Example of a report:

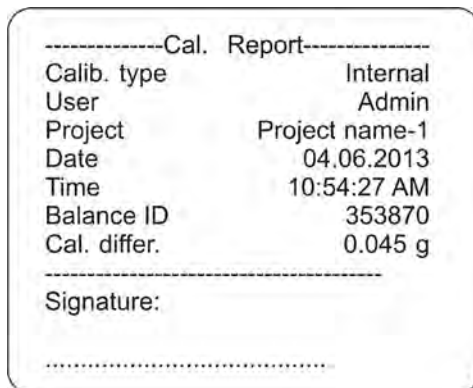

13.2. Header printout

P5.2 HEADER, is a group of parameters enabling user to declare data that is to be printed on the header printout.

The settings are valid only for WEIGHING mode.

P5.3 HEADER

P5.2.1	DASHES		YES
P5.2.2	WORKING MODES		YES
P5.2.3	DATE		YES
P5.2.4	TIME		YES
P5.2.5	SCALE TYPE		YES
P5.2.6	BALANCE ID		YES
P5.2.7	USER		YES
P5.2.8	PRODUCT		YES
P5.2.9	VARIABLE 1		YES
P5.2.10	VARIABLE 2		YES
P5.2.11	BLANK LINE		YES
P5.2.12	CAL.REPORT		YES
P5.2.13	NON-STANDART PRNT.		NONE / NSTD.PRN. 1 / NSTD. PRN. 2 / NSTD.PRN.3 / NSTD. PRN.4

- **P5.2.1 DASHES**

Enables printing out a line of separating dashes.

- **P5.2.2 WORKING MODES**

Enables printing out the name of a working mode.

- **P5.2.3 DATE**

Enables printing out the date in the header.

- **P5.2.4 TIME**

Enables printing out the time in the header.

- **P5.2.5 SCALE TYPE**

Enables printing out the scale type.

- **P5.2.6 BALANCE ID**

Enables printing out balance ID number.

- **P5.2.7 USER**

Enables printing out the name of a logged-in user.

- **P5.2.8 PRODUCT**

Enables printing out the name of a selected product.

- **P5.2.9 VARIABLE 1**

Enables printing out the value of VARIABLE 1.

- **P5.2.10 VARIABLE 2**

Enables printing out the value of VARIABLE 2.

- **P5.22.11 BLANK LINE**

Enables printing out an empty separating line.

- **P5.2.12 CAL. REPORT**

Enables printing out a report from the last adjustment, according to the settings declared for the adjustment report printout.

- **P5.2.13 NSTD. PRINT.**

Enables printing out one of the four non-standard printouts on the header printout.

You can choose one from the following options: NONE / NSTD. PRN 1 / NSTD.PRN.2/NSTD.PRN. 3 / NSTD. PRN.4

Choose one of the options for the above-mentioned parameters (**P5.2.1 - P5.2.12**).

- NO** - do not print on the report
- YES** - print on the report

For parameter **P5.2.13**, select one of the available options:

NONE / NSTD.PRN. 1 / NSTD.PRN. 2 / NSTD.PRN. 3 / NSTD.PRN. 4

The way of entering non-standard printouts is described further in this manual.

Example of a report:

Working modes	Weighing
Date	24.07.2013
Time	7:37:30
ScaleType	AS
Balance ID	10353870
User	ADMIN ENG
Product	Tablet

13.3. Printout of measurement result – GLP PRINTOUT

P5.3 GLP PRINTOUT, is a group of parameters enabling user to declare data that is to be printed on the printout of measurement result.

The settings are valid only for WEIGHING mode.

P5.3 GLP PRNT.

P5.3.1	DATE		YES
P5.3.2	TIME		YES
P5.3.3	USER		YES
P5.3.4	PRODUCT		YES
P5.3.5	VARIABLE 1		YES
P5.3.6	VARIABLE 2		YES
P5.3.7	NET		YES
P5.3.8	TARE		YES
P5.3.9	GROSS		YES

P5.3.10 CURR.RES.		YES
P5.3.11 CAL. REPORT		YES
P5.3.12 NSTD.PRNT.		NONE / NSTD.PRN. 1 /NSTD.PRN. 2 / NSTD. PRN.3 / NSTD.PRN. 4

- **P5.3.1 DATE**

Enables printing out the date of measurement.

- **P5.3.2 TIME**

Enables printing out the time of measurement.

- **P5.3.3 USER**

Enables printing out the name of a logged-in user.

- **P5.3.4 PRODUCT**

Enables printing out the name of the product that was weighed.

- **P5.3.5 VARIABLE 1**

Enables printing out the value of VARIABLE 1.

- **P5.3.6 VARIABLE 2**

Enables printing out the value of VARIABLE 2.

- **P5.3.7 NET**

Enables printing out net mass value in a basic unit (calibration unit).

- **P5.3.8 TARE**

Enables printing out the tare value in the current unit.

- **P5.3.9 GROSS**

Enables printing out the gross mass value in the current unit.

- **P5.3.10 CURR. RES.**

Enables printing out the current measurement result (NET mass) in the current unit.

- **P5.3.11 CAL. REPORT**

Enables printing out a report from the last adjustment, according to the settings declared for the adjustment report printout.

- **P5.3.12 NSTD. PRNT.**

Enables printing out one of the four non-standard printouts on the measurement printout.

You can choose one of the following options: NONE / NSTD. PRN 1 / NSTD.PRN.2/NSTD.PRN. 3 / NSTD. PRN.4

The way of entering non-standard printouts is described further in this manual.

Example of a printout:

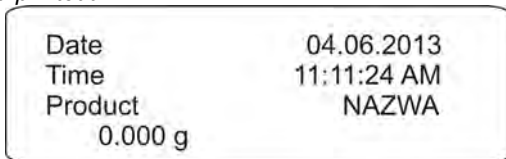

13.4. Footer printout

P5.4 FOOTER, is a group of parameters enabling user to declare data that is to be printed on the footer printout.

The settings are valid only for WEIGHING mode.

P5.4 FOOTER

P5.4.1	WORKING MODES		YES
P5.4.2	DATE		YES
P5.4.3	TIME		YES
P5.4.4	SCALE TYPE		YES
P5.4.5	BALANCE ID		YES
P5.4.6	USER		YES
P5.4.7	PRODUCT		YES
P5.4.8	VARIABLE 1		YES
P5.4.9	VARIABLE 2		YES
P5.4.10	DASHES		YES
P5.4.11	BLANK LINE.		YES
P5.4.12	CAL.REPORT		YES
P5.4.13	SIGNATURE		YES
P5.4.14	NSTD. PRNT.		NONE / NSTD.PRN. 1 / NSTD.PRN.2/NSTD.PRN.3 / NSTD. PRN.4

- **P5.4.1 WORKING MODES**

Enables printing out of the name of a working mode.

- **P5.4.2 DATE**

Enables printing out of the date in the footer.

- **P5.4.3 TIME**

Enables printing out the time in the footer.

- **P5.4.4 SCALE TYPE**

Enables printing out the scale type.

- **P5.4.5 BALANCE ID**

Enables printing out balance ID number.

- **P5.4.6 USER**

Enables printing out the name of a logged-in user.

- **P5.4.7 PRODUCT**

Enables printing out the name of a selected product.

- **P5.4.8 VARIABLE 1**

Enables printing out the value of VARIABLE 1

- **P5.4.9 VARIABLE 2**

Enables printing out the value of VARIABLE 2

- **P5.4.10 DASHES**

Enables printing out a line of separating dashes

- **P5.4.11 BLANK LINE**

Enables printing out an empty separating line

- **P5.4.12 CAL. REPORT**

Enables printing out a report from the last adjustment, according to the settings declared for the adjustment report printout.

- **P5.4.13 SIGNATURE**

Enables providing an area for the signature of a user performing the adjustment.

- **P5.4.14 NSTD. PRNT.**

Enables printing out one of the four non-standard printouts on the footer printout.

You can choose one of the following options: NONE / NSTD. PRN 1 / NSTD.PR.N.2 / NSTD.PR.N. 3 / NSTD. PRN.4

The way of entering non-standard printouts is described further in this manual.

Choose one of the options for the above-mentioned parameters (**P5.4.1 - P5.4.13**).

NO - do not print on the report

YES - print on the report

For parameter **P5.4.14**, select one of the available options:

NONE / NSTD.PR.N. 1 / NSTD.PR.N. 2 / NSTD.PR.N. 3 / NSTD.PR.N. 4

The way of entering non-standard printouts is described further in this manual.

Example of a footer printout:

The image shows a rounded rectangular box representing a footer printout. It contains the following text:

Date	24.07.2013
Time	7:41:10
User	ADMIN ENG
Signature	

There are dashed lines above and below the text.

13.5. Printout of report on drying process

P5.5 DRYING PROCESS PERORT, is a group of parameters enabling user to declare data that is to be printed on the report on drying.

Report on drying process is divided into three individually set parts:

- header
- measurement
- footer

The settings are valid only for DRYING mode.

13.5.1. Report on drying – header

P5.5.1. HEADER

P5.5.1.1.	DATE		YES
P5.5.1.2.	TIME		YES
P5.5.1.3.	SCALE TYPE		YES
P5.5.1.4.	BALANCE ID		YES
P5.5.1.5.	USER		YES
P5.5.1.6.	PRODUCT		YES
P5.5.1.7.	PROGRAM		YES
P5.5.1.8.	DRY. PARAM.		YES
P5.5.1.9.	VARIABLE 1		YES
P5.5.1.10.	VARIABLE 2		YES
P5.5.1.11.	START MASS		YES
P5.5.1.12.	BLANK LINE		YES
P5.5.1.13.	NSTD. PRNT.		NONE / NSTD.PRN.
	1 / NSTD.PRN.2 / NSTD.PRN.3 / NSTD. PRN.4		

- **P5.5.1.1. DATE**

Enables printing out of the date in the footer.

- **P5.5.1.2. TIME**

Enables printing out of the time in the footer.

- **P5.5.1.3. SCALE TYPE**

Enables printing out the scale type.

- **P5.5.1.4. BALANCE ID**

Enables printing out balance ID number.

- **P5.5.1.5. USER**

Enables printing out the name of a logged-in user.

- **P5.5.1.6. PRODUCT**

Enables printing out the name of a selected product.

- **P5.5.1.7. PROGRAM**

Enables printing out the name of a currently selected drying mode.

- **P5.5.1.8. DRYING PARAM.**

Enables printing drying parameters that are to be valid when drying a sample.

- **P5.5.1.9. VARIABLE 1**

Enables printing out the value of VARIABLE 1.

- **P5.5.1.10. VARIABLE 2**

Enables printing out the value of VARIABLE 2.

- **P5.5.1.11. INITIAL MASS**

Enables printing out the value of tested sample initial mass.

- **P5.5.1.12. BLANK LINE**

Enables printing out an empty separating line.

- **P5.5.1.13. NSTD. PRNT**

Enables printing out one of the four non-standard printouts on the header printout.

You can choose one from the following options: NONE / NSTD. PRN 1 / NSTD.PRN.2/NSTD.PRN. 3 / NSTD. PRN.4

The way of entering non-standard printouts is described further in this manual.

For the parameters described above i.e. **P5.5.1.1 to P5.5.1.12** you should choose from:

NO - do not print in the header

YES - print in the header

For the parameter **P5.5.1.13**, you should choose one of the following options: NONE / NSTD.PRN. 1 / NSTD. PRN 2 / NSTD.PRN 3 / NSTD. PRN.4

13.5.2. Report on drying – measurement

P5.5.2. MEASUREMENT

P5.5.2.1. TIME/RESULT | YES

- **P5.5.2.1. TIME/RESULT**

Enables printing (real-time printout) time of the drying result with the time interval set in drying parameters.

13.5.3. Report on drying – footer

P5.5.3. FOOTER

P5.5.3.1.	STATUS		YES
P5.5.3.2.	DRYING TIME		YES
P5.5.3.3.	END MASS		YES
P5.5.3.4.	RESULT		YES
P5.5.3.5.	BLANK LINE.		YES
P5.5.3.6.	SIGNATURE		YES
P5.5.3.7.	NSTD. PRNT.		NONE / NSTD. PRNT. 1 / NSTD. PRNT. 2 / NSTD. PRNT. 3 / NSTD. PRNT. 4

- **P5.5.3.1. STATUS**

Enables printing status of drying process summary (Completed/Aborted)

- **P5.5.3.2. DRYING TIME**

Enables printing total drying time

- **P5.5.3.3. OUTPUT MASS**

Enables printing output mass of a tested sample

- **P5.5.3.4. RESULT**

Enables printing final result of the drying process

- **P5.5.3.5. BLANK LINE**

Enables printing out an empty separating line

- **P5.5.3.6. SIGNATURE**

Enables providing an area for the signature of a user performing the adjustment.

- **P5.5.3.7. NSTD. PRNT.**

Enables printing out one of the four non-standard printouts on the footer printout.

You can choose one from the following options: NONE / NSTD. PRN 1 / NSTD.PRNT.2/NSTD.PRNT. 3 / NSTD. PRN.4

The way of entering non-standard printouts is described further in this manual.

For the parameters described above i.e. **P5.5.3.7** - **P5.5.3.6** you should choose from:

- NO** - do not print in the header
YES - print in the header

For the parameter **P5.5.3.7**, you should choose one of the following options:
NONE / NSTD.PR.N. 1 / NSTD. PRN 2 / NSTD.PR.N 3 / NSTD. PRN.4

13.6. Non-standard printouts

The balance's software enables entering 4 non-standard printouts. Each of them can consist of approximately 160 characters.

Non-standard printout may include:

- Variables depending on the working mode and other needs (mass, date etc.),
- Permanent text in the user menu, it should be remembered, however, to use CAPITAL letters of Latin alphabet,
- Non-standard printout can contain approximately 160 characters (typed as a single line).

13.6.1. Inserting texts

Variables having the same values for all modes.

%%	Printout of a “%” character
%V	Current net mass in the current unit
%N	Current net mass in the basic unit
%G	Current gross mass in the basic unit
%T	Current tare mass in the basic unit
%D	Current date
%M	Current time
%I	Balance number
%R	Program number
%P	Project number
%U	User number
%F	Name of current function – working mode
%C	Date and time of the last adjustment

%K	Type of the last adjustment
%S	Currently weighed product
%Y	Deviation for the last adjustment
%1	Variable 1
%2	Variable 2

Variables dependent on the currently operated working mode

Variable	Description	Mode for which the variable is active
%W	Standard mass 1 pcs	COUNTING PIECES
%H	High threshold	CHECKWEIGHING
%L	Low threshold	
%A	Target mass	DOSING
%B	Reference mass	DEVIATIONS

Non-standard characters used when designing non-standard printouts

\\	a single „\” character
\C	CRLF
\R	CR
\N	LF
\T	Tabulator
\F	Form feed (for PCL printers)
%E	Paper crop for EPSON printers

Every single printout can contain max 160 characters (letters, numerals, non-standard characters, spaces). A user can apply non-standard characters depending on type of data that is to be printed out.

Example 1:

"RADWAG"

DATE: <current measurement date>

TIME: <current measurement time>

PRODUCT MASS: <current mass indication>

*****SIGNATURE:.....

<current working mode>

Enter printout content settings and design the printout using respective data variables and characters for text format.

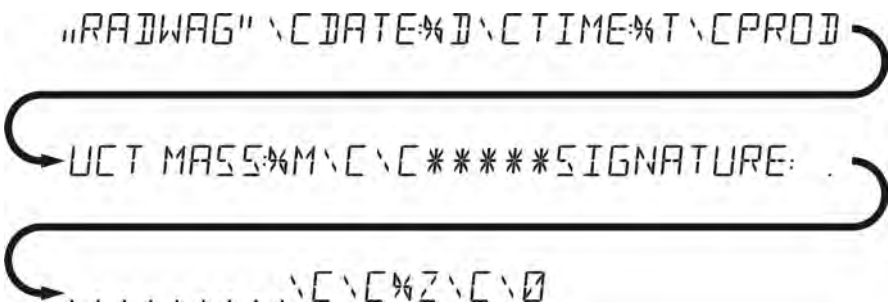

Example 2:

To crop the paper after the printout had been carried out by EPSON printer (if the printer is equipped with an autocutter blade) the user must select (for a given printout: HEADER, GLP PRINTOUT or FOOTER) an option of non-standard printout 1,2,3 or 4 with <%E> value available and select this printout for a given printout settings.

In such case <SUFFIX> command should stay empty.







Paper must be cropped underneath the FOOTER.

Example settings:

- P5.4.14 STANDARD PRINTOUT | NSD. PRN. 1
- P5.5 NSD. PRN. 1 | %E

Instruction on inserting the text

By means of balance

	Selecting a character to be replaced. Moving a cursor or an active (blinking) character to the right.
	Selecting a character to be replaced. Moving a cursor or an active (blinking) character to the left.
	Changing the character by one value down
	Changing the character by one value up
	Deleting a character
	Inserting a character

By means of computer keyboard of USB type

A computer keyboard of USB type can be connected to a balance, this enables easier and quicker editing of the printouts.

Willing to insert any text, it is necessary to select a respective menu option and, using the keyboard, type the text. Next the text must be confirmed by means of Enter button.

CAUTION:

It is important to type variables, used for non-standard printouts, in capital letters.

13.7. Variables

Variable is defined as alphanumeric data which can be linked to printouts, products or other information related to weighing. Every variable is characterized by its content, the content must be given. Variables are used for entering various data during the weighing process, e.g. serial number or batch number. The program allows to enter two variables. Each can consist of max 32 characters.

In order to input a variable content, the user needs to enter variable settings (parameter P5.9 – VARIABLE 1 or P5.10 – VARIABLE 2) and enter the respective values using direction keys (arrows) on the balance keypad or a computer keyboard. Procedure for entering texts is the same as for non-standard printouts.

14. DATABASES

The balance software has 3 databases that can be edited (USERS, PRODUCTS, TARES) as well as 2 databases (WEIGHMENTS AND ALIBI), to which all the measurements, carried out by means of the balance, are saved.

Data range saved within particular databases:

USERS – 10 different users.

PRODUCTS – 1 000 different products.



PROGRAMS – 100 different drying programs

TARES – 100 different weights of the packaging.

WEIGHMENTS – 1 000 consecutive measurements

DRYING PROCESS REPORTS – 1 000 consecutive reports

Operations on databases: USERS, PRODUCTS, PROGRAMS and TARES:

	Deleting the selected record
	Inserting a new record

For detailed information on inserting and deleting records read instruction below.

14.1. Users

USERS – 10 different users.

Each user is characterized by the following data:

NAME (30 characters), **CODE** (6 characters),

PASSWORD (8 characters, digits only),

ACCESS (USER, ADVANCED, ADMIN),

LANGUAGE (any of the available).

Access levels

The balance software has three access levels: *USER*, *ADVANCED*, *ADMINISTRATOR*.

Once the balance is switched on, the display stays active all the time, this enables carrying out mass measurements even when no user is logged-in.

User parameters, databases and software functions may be edited depending on the access level granted to a particular user. Access levels are presented in the table below.

Authority	Access levels
USER	Access to parameters in the submenu: <Reading> and settings in parameter group <Others> except for <Date and Time>. All the weighing processes can be started and carried out at this time. The user can preview information in <Databases> and define universal variables.
ADV	Access to editing parameters in the submenu: <Reading>; <Working modes>; <Communication>; <Devices>; <Others> except for <Date and Time>. All the weighing processes can be started and carried out at this time.
ADMIN	Access to all user parameters and functions and to editing databases.

In order to add a user, follow the scheme shown below, add a user and assign a name to him/her.

The sequence of screens and actions for adding a user is as follows:

- Initial screen: **PROGRAM** 0.000g. Action: Database key.
- Screen: **65.1.1** ADD NEW RECORD?. Action: Profile key.
- Screen: **65.1.1.1** NAME NEW. Action: F1 key.
- Screen: **65** VIEW / EDIT. Action: F1 key.
- Screen: **65.1** USERS. Action: F1 key.
- Screen: **65.1.1.1** NOWAK JAN. Action: F2 key.
- Screen: **65.1.1** NOWAK JA. Action: F1 key.
- Screen: **65.1.1** CODE. Action: F1 key.

Once the user's name is added, follow the procedures shown below:
User's code – Max 6 characters

Screen: **65.1.1.2** CODE. Action: F1 key.

User's password – Max 8 numbers

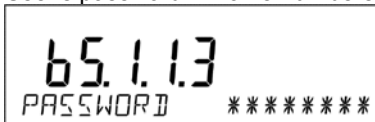

Select the access level

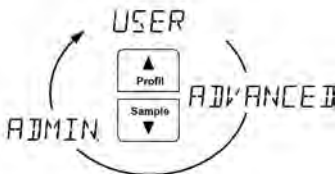
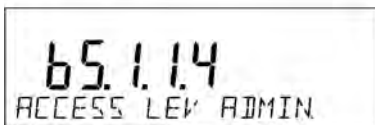
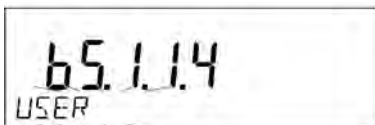
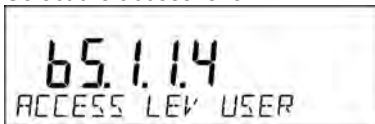

Select the language

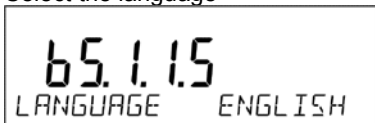

Once all of the data is inserted, you can return to the weighing mode.

In order to select a user, follow the logging-in procedure described in section 8 in this manual.

In order to remove a user you should follow this procedure:

- Enter the user database – as in the description above
- Select the user that is to be removed from the list
- Press  button
- The software shows <DELETE?> message in the bottom line

- Confirm by pressing  button
- When confirmed, the software removes the selected user from the list
- Return to the weighing mode

14.2. Products

PRODUCTS – 1000 different products. The following data can be inserted for each product: NAME (30 characters), CODE (6 characters), EAN (16 characters), MASS (with the accuracy of a reading unit), TARE (mass of the packaging relating to a particular product with the accuracy of a reading unit), MIN (low threshold for the <CHECKWEIGHING> mode, to be inserted with the accuracy of a reading unit), MAX (high threshold for the mode <CHECKWEIGHING>, should be inserted with the accuracy of a reading unit), TOLERANCE (tolerance thresholds to [±] for <DOSING> mode, entered as a % of the target mass).

In order to add a product, you should enter products database and add name of the product (follow the procedure as in the section above).



Give details about the product.

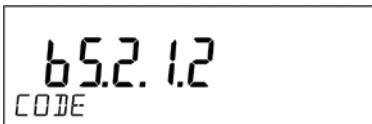

65.2.11
NAME NEW



65.2.15
TARE 0000



65.2.12
CODE



65.2.16
MIN 0000



65.2.13
EAN



65.2.17
MAX 0000



65.2.14
MASS 0000



65.2.18
TOLERANCE 0000



65.2.19
PROGRAM



14.3. Drying programs

PROGRAMS – 100 different drying programs. The following data can be inserted for each program: NAME (30 characters), CODE (6 characters), DRYING MODES (drying mode: STANDARD/QUICK/MILD/STEP), DRYING PAR. (drying parameters to be valid when drying a sample, these are temperature, time, the parameters must be completed depending on a selected mode), FINISH MODE (auto switch-off options for a drying process: AUTO1, AUTO2, AUTO3, AUTO4, AUTO5, MANUAL, TIME-DEFINED, DEFINED), FINISH PAR. (parameters for finishing the process, the parameters are to be valid when drying a sample, these are time, difference of weight, the parameters must be completed depending on a selected auto switch-off option), RESULT (unit for a weighing result obtained during drying process: %M, %D, %R, G, the unit is to be displayed and printed while drying a sample), PRINTOUT INTERVAL (time interval between successive measurement printouts performed during the drying process, it is given in seconds, range 0-120s).

In order to add a program, you should enter programs database and add name of the program (follow the procedure as in the section above).

65.3
PROGRAMS



65.3.1
NONE



Give details about the program.

65.3.1.1
NAME NEW



65.3.1.2
CODE



65.3.1.3
DRY MODE STANDARD



65.3.1.4
MODE PARAMETERS



65.3.1.4.1
TEMPERATURE 120°C



65.3.15
AUTO OFF TIME--DE



65.3.16
FINISH MODE PAR



65.3.16.1
TIME 000000



65.3.17
WYNIK %M



65.3.18
INTERVAL 20



14.4. Tares

TARES – 100 different weights of the packaging. The following data can be inserted for each packaging: NAME (30 characters), TARE (packaging weight, enter a value with the accuracy a reading unit).

In order to add tare – packaging weight, you should enter tare database and add name of the tare (follow the procedure as in the section above).

65.4
TARES



65.4.1
NONE



Give details about the packaging.

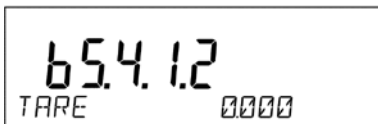
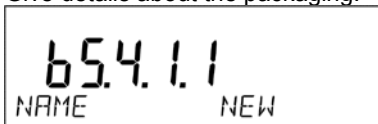

14.5. Weighments

Weighments database is non-editable i.e. the data relating to the weighments is saved automatically. A user has a possibility of viewing this data and printing it out or exporting it to a PENDRIVE; if such a need occurs (go to later sections for more information on export).

The balance software allows user to save and store up to 1 000 measurements carried out on the balance. This occurs automatically, after pressing the <PRINT> button, no additional actions or modification of settings.

Additional data is saved along with the measurement.

- Date of the measurement
- Time of the measurement
- Measurement result (mass)
- Tare value
- Name of the product that has been weighed
- Person carrying out the measurement (logged-in user)
- Working mode in which the measurement has been carried out
- Value of variable 1 and 2

The software saves the measurements in a so called loop, i.e. when the measurement 10 001 is saved, the measurement 1 is automatically deleted from the balance memory.

The measurements saved in the balance memory cannot be deleted.

It is possible for a user to view and print out the data saved in the WEIGHMENTS memory.

Procedure:

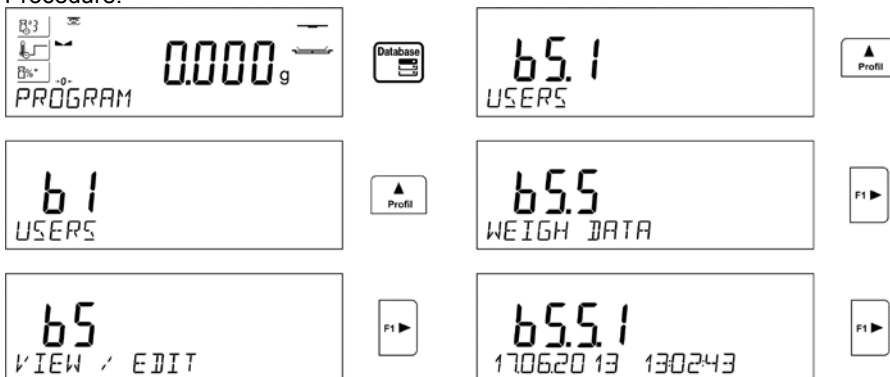

Each measurement is saved with its individual number. The format is: b4.4.n, where <n> is the consecutive number of the saved measurement. In the bottom line the date and time are displayed for every single measurement.

To swap between measurements recorded in database, use the arrow buttons,

or . Pressing one of these buttons lets the user move to the next measurement either up or down the list.

To view the remaining data relating to a respective measurement, first select the the

measurement in question, next press button:

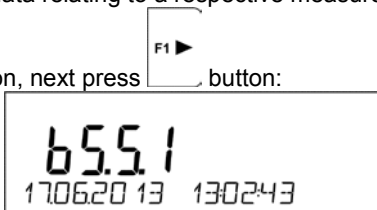

The software automatically shows the data relating to the measurement, data is presented in the bottom line of the balance display.

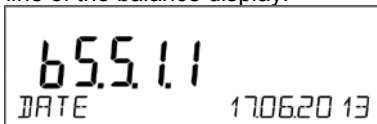

To swap between data relating to the measurement, press or . The data relating to the measurement can be printed out by selecting the option

<PRINT> and pressing button.

65.5.11
DATE 170620 13

65.5.16
USERS NOWAK J.

65.5.12
TIME 130243

65.5.17
WORKING MODES WEIGH

65.5.13
RESULT 10.718 G



65.5.18
VARIABLE 1 1234



65.5.14
TARE 0.000 G

65.5.19
VARIABLE 2 5678

65.5.15
PRODUCT TABLETKA

65.5.110
PRINT



Printout example for a particular record:

Date 21.06.2013
Time 13:05:02
User
Product

Tare 0.000 g
Gross 0.000 g

-----Cal. raport-----

Cal. Type Internal
User
Project 1234567890123459
Date 16.07.2013
Time 13:27:09
Balance ID 10353870
Cal. Diff. -0.004 g

Signature

.....

The data that is to be printed out, depends on the settings of parameter P5.3 GLP PRINTOUT. The data set for the printout (<YES> option selected), is printed out also in WEIGHMENTS database (see sec. 13.3.)

14.6. Reports on drying process

The balance memory allows the user to save and store up to 1 000 reports on drying processes performed by means of the moisture analyzer.

The reports are saved automatically upon completion of each drying process, no additional action needs to be taken, no settings modification performed.

Additional data is saved along with the measurement.

- Date of the measurement
- Time of the measurement
- Initial sample weight
- Status
- Time of the drying process
- Output sample weight
- Measurement result (mass)
- Product
- User
- Program
- Value of variable 1 and 2

The software saves the measurements in a so called loop, i.e. when the measurement 1 001 is saved, the measurement 1 is automatically deleted from the balance memory.

The measurements saved in the balance memory cannot be deleted.

It is possible for a user to view and print out the data saved in the memory.

Procedure:

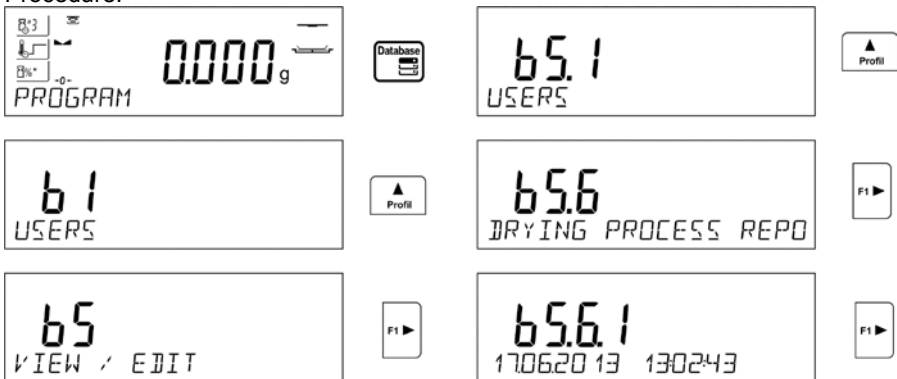

Each measurement is saved with its individual number. The format is: b5.6.n, where <n> is the consecutive number of the saved measurement. In the bottom line the date and time are displayed for every single measurement.

To swap between measurements recorded in database, use the arrow buttons,



or

Pressing one of these buttons lets the user move to the next measurement either up or down the list.

To view the remaining data relating to a respective measurement, first select the the



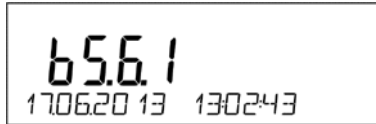

measurement in question, next press button:

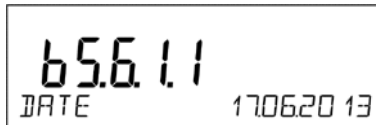

The software automatically shows the data relating to the measurement, data is presented in the bottom line of the balance display.



To swap between data relating to the measurement, press  or . The data relating to the measurement can be printed out by selecting the option

<PRINT> and pressing  button.

65.6.11
DATE 170620 13

65.6.17
RESULT 0507 G

65.6.12
TIME 130243



65.6.18
PRODUCT NEW

65.6.13
START MASS 0537 G

65.6.19
USER NOWAK J



65.6.14
STATUS COMPLETE

65.6.110
PROGRAM TEST

65.6.15
DRYING TIME 01408

65.6.111
VARIABLE 1 1234

65.6.16
END MASS 0507 G

65.6.112
VARIABLE 2 5678

65.6.113
PRINT



Printout example for a particular record:

-----Report on drying process-----

Date	01.01.2000
Time	0:10:12
User	Kowalski Jan
Product	Tea
Program	Test
Drying parameters	
Drying mode	Standard
	120°C
Auto off	Auto3
	1mg/60s
Result	g
Interval	20s
Input weight	0.537 g
0:00:00	0.537 g
0:00:20	0.536 g
0:00:40	0.518 g
0:01:00	0.509 g
0:01:20	0.508 g
0:01:40	0.507 g
0:02:00	0.507 g
0:02:01	0.507 g
Status	Completed
Output weight	0.507 g
Result	0.507 g



To return to the weighing mode press  button repeatedly.

15. DATABASES EKSPORT AND IMPORT

This option allows the user to:

- Archive data relating to the carried out weighments – WEIGHMENT database and DRYING PPROCESS REPORTS database.
- Copy the products, tares and users databases between balances of this series.

This can be performed by using external USB memory stick. For ensuring correct cooperation, the memory stick shall contain **<FAT files system>**.

Plug the memory stick into USB 1 – TYPE A port.

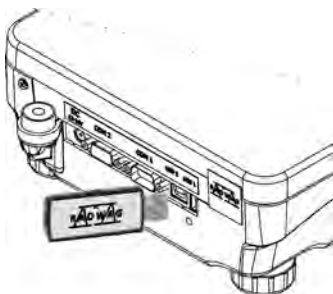

The balance automatically detects the memory stick, the message enabling operations relating to the export or import of the database is displayed.



The following options are available when entering this parameter:

- Database EXPORT

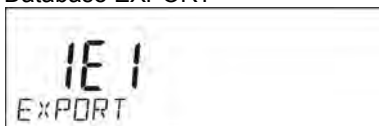

- Database IMPORT

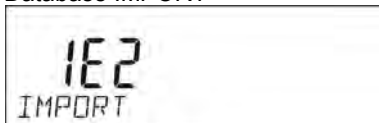

15.1. Database export

To export the database, select an option EXPORT.



The following functions are available:

- Export of all the databases
- Export of users databases
- Export of product databases
- Export of program databases
- Export of tares databases
- Export of weighments
- Export of drying process reports, recorded in ALIBI memory
- Export of users parameters

After selecting <ALL DATABASES> option, the balance software creates files on the memory stick. The files are of relevant names and data from individual databases is saved to them. The files are characterized by special extensions, saved data is encoded in a way that the files cannot be read or seen by standard computer programs.

Special computer software manufactured by RADWAG company is used to read data from database files: DRYING PROCESS REPORTS and WEIGHMENTS. Data from the files, to which PRODUCTS, USERS, and TARES databases data is saved, is read automatically for option <IMPORT>.

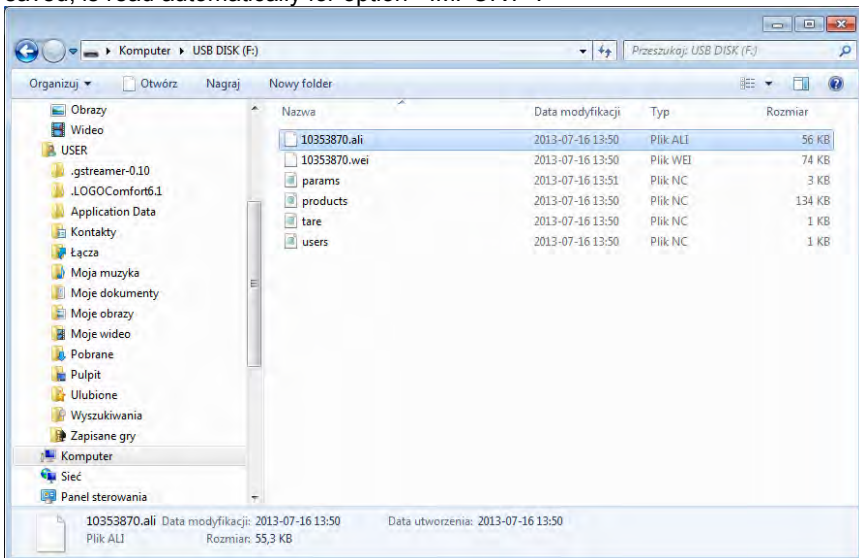

15.2. Database import

<IMPORT> function allows transfer of data, recorded in balance databases, from one balance to another. This is a quick and reliable way for entering the data without any mistakes.

To import the database, plug a memory stick to USB port, next select IMPORT option and choose one of the following:



The following options are available:

- Import of all databases
- Import of users databases
- Import of products databases
- Import of programs databases
- Import of tares databases
- Import of users parameters

The data from DRYING PROCESS REPORTS and WEIGHMENTS databases cannot be imported.

15.3. Measurement data printout

Balance software allows the user to save data relating to a measurement on an external USB memory stick.

The operation can be performed as follows:

- Plug a memory stick into USB port
- Abandon <IMPORT/EXPORT> option, which is automatically started by

pressing  button

- Set <PENDRIVE> option for parameter P4.2.1 DEVICES/PRINTER/PORT>
- Return to the weighing mode

- From this moment on, every single pressing of the button  leads to saving the measurement data (compatible with the settings for GLP0 PRINTOUT) in a text file, the text file is automatically created by the balance software. The file name is: *printout.txt*.

- Switch the balance off by pressing  button so that the data is saved in the file. Only then can you remove the pendrive from the port and read the data on a computer.

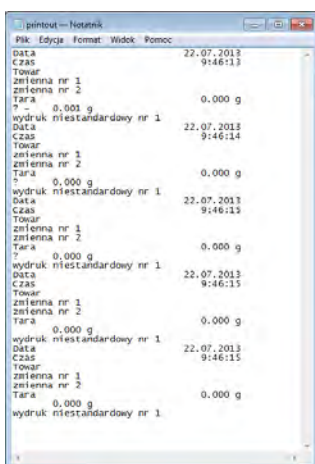
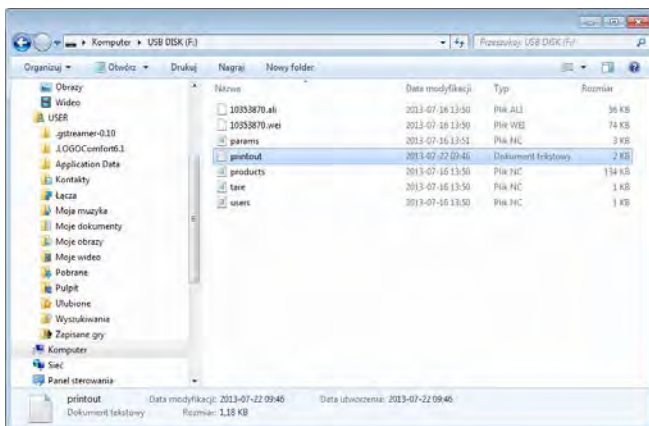

The data can be printed out on any printer connected to the computer.

More data can be recorded in the same file. The balance software will add the data to the file that has already been created on a memory stick. Consequently, a user can continue saving measurements in the same file once created.

CAUTION:

CAUTION:

When software detects a memory stick, menu <P8 IMPORT/EXPORT> becomes accessible.

All the operations relating to export and import that are described above can be performed using this menu.

16. PREPARING SAMPLES FOR DRYING

This part of the manual contains information on how parameters shall be set if the user wants to obtain optimal results when carrying out tests. Rules for particular drying parameters selection is presented, wherein the said selection depends on the tested sample material.

16.1. Rules for measurement of moisture analyzer humidity content

Measurement of moisture content in a tested sample is carried out by determining loss of mass in a sample by its heating (humidity evaporation from a sample). RADWAG moisture analyzer comprises two components: a precision balance and a drying chamber. Compared to standard moisture content determining methods, the measurements with application of RADWAG moisture analyzer is much quicker and does not require additional mathematical calculations (a result of moisture content is previewed on an ongoing basis during product testing process).

Independently on moisture content determining method, the measurement accuracy is highly influenced by means of sample preparation and selection of testing parameters, such as:

- Sample size
- Sample type
- Drying temperature
- Drying time

In practice, the measurement accuracy is not as important as the speed of obtaining measurement result (control over technological process). Thus, heating a sample (with application of a halogen filament) carried out by a moisture analyzer, makes the measurement process very time efficient and short. Measurement speed can be additionally increased by appropriate adjusting moisture analyzer's parameters depending on tested substances.

Optimum temperature and drying time depend on sample type and size, and anticipated measuring accuracy. Selection of drying parameters can only be carried out on basis of test measurements.

16.2. Sampling and preparation

Sample features, its preparation and size are very important factors influencing the speed and accuracy of measurement process.

Means of sampling and preparation are extremely important for repeatability of measurement results, as a sample should be a representative part of tested substance.

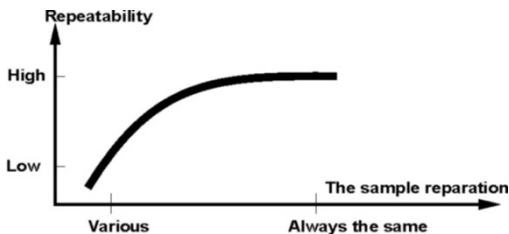

Final measurement result is vastly conditioned by precise and considered sample preparation. A sample used for analysis has to represent the total structure of tested material. Sampling process should determine: sampling means, sample disintegrating, particle size after disintegration, sample uniformity and other. The sampling process should be carried out as quickly as possible, so that a sample does not loose or absorb humidity from surrounding area.

Applied sampling standards should match individual user needs and requirements of tested material, its consistence and sample size.

Number of samples

Increasing number of tested samples also increases statistic measurement certainty. Number of samples depends on uniformity of tested material, its purity, accuracy of applied measuring method and anticipated accuracy of obtained results.

Material mechanical disintegrating for measurements

Applied disintegrating method should be selected appropriately to tested material. Substances that are hard and brittle (crisp) can be disintegrated by cutting. Grinding such substances may cause their heating and thus humidity vaporization, resulting in unreliable measurement results. Unless a substance can be prepared for measurement otherwise than grinding, any possible moisture content loss should be calculated.

Use of high-silica sand

Ensuring optimum substance drying requires that a sample has the largest possible surface for moisture content vaporization. Test results of moisture content for substance with surface in a form of a shell (e.g. glucose syrup) or doughy (e.g. butter), can be much more reliable if a sample is mixed with a dried high-silica sand (improvement of measurement accuracy and repeatability). While using mixture, disposable weighing pan with extended brim must be applied (greater volume of a sample).

Grease in a form of paste or melting substances

Such substance requires testing with use of a filter made of glass fibre, which considerably increases active evaporation surface by separating the substance between the fibre. Initial filter drying is necessary only in case of measurements which require very high accuracy.

Liquid substances

It refers to liquid substances, which by creation of drops on their surface, caused by surface tension, may render difficulties in drying process. In such cases, it is proved to use a glass fibre filter to shorten measurement time. The filter causes separating tested liquid around the fibres, and increasing active evaporating surface. Initial filter drying is necessary only in case of measurements which require very high accuracy.

Substances with structure of leather, or temperature sensitive

In case of such substances it is proved to use a glass fibre filter. While testing, a substance is placed on a drying pan, and sample surface is covered with a filter, which protects the sample from direct heat radiation. In such case, the sample is heated by convection (which is milder than radiation).

Substances containing sugar

The surface of such substances often may caramelize during testing procedure. Therefore, it is recommended to use thin layer of a sample, and moderate drying temperature.

Sample distribution on a drying pan:

Loose materials

Dried in their natural state, i.e. in their natural form or disintegrated. Sample disintegration causes smaller dispersion between the following measurements. Sample mass should not be too high, and the sample should be evenly spread on whole surface of the drying pan.

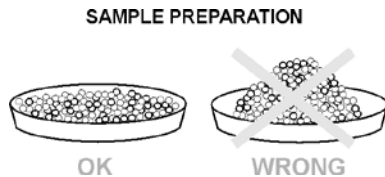

Liquid substances

Semi-fluid substances are dried in their natural form. Large amount of grease (fat) occurring in some of substances makes moisture content determination difficult. In such case it is recommended to use additional components, which increase sample's active surface and aid moisture content releasing process from a sample. Such components are high silica sand, blotting paper or filter. Before drying a tested substance, initially dry the additional component, so that its humidity is close to zero.

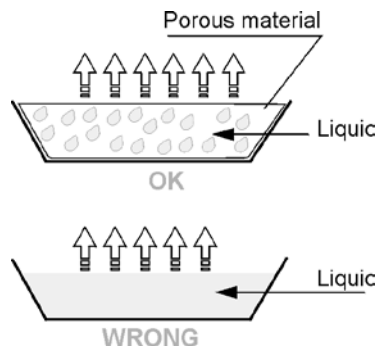

Solid objects

Depending on solid object's structure (dense or loose), moisture content determining process may take short or long time. The size of solid's surface determines the speed of drying process, and measurement reliability. Thus, the surface of a solid object should be as large as possible. Since solid objects release moisture through their outer surface, sample thickness is another important factor.

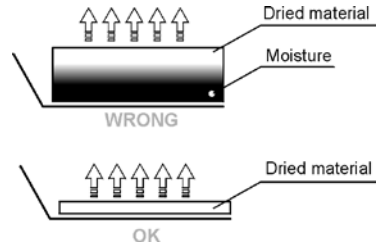

17. SELECTION OF DRYING PARAMETERS

17.1. Selecting optimum mass for a sample

Sample mass influences the accuracy of measurement result and measurement time. Higher mass of a sample, causes higher amount of water (moisture content) which needs to evaporate, and therefore measurement time is also longer. Obtaining short measurement time is feasible in case of small sample mass, but sample mass cannot be too small, as it may negatively influence required measurement accuracy.

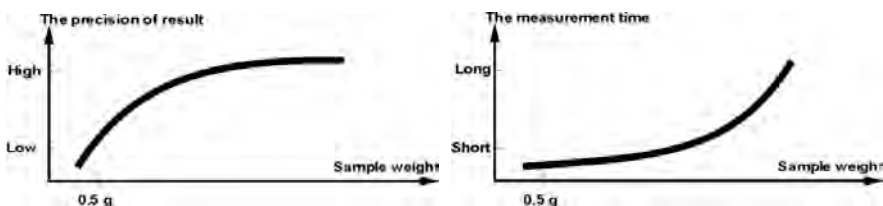

17.2. Influence of sample weight on measurement result repeatability

Sample mass has considerable influence on repeatability of measurement results obtained on a moisture analyzer. Relation between sample mass and repeatability is presented in below table.

Sample weight	Repeatability
~ 2g	+/-0,1%
~ 10g	+/-0,02%

Data provided in the above table refer to an ideal and uniform sample, and an assumption, that moisture content has completely evaporated from tested sample during testing process, and the sample has not decomposed (e.g. humid high-silica sand).

Measurement results are always subject to uncertainty related to a sample and repeatability of used moisture analyzer. In practice, it means that obtained measurement result may exceed repeatability values provided above.

17.3. Drying temperature

Drying temperature has the largest impact on drying time. Temperature value depends on type of dried substance. Too low drying temperature causes too low moisture content evaporation (under-dried sample), and consequently unnecessary extending of measurement time. Too high drying temperature causes burning of dried sample (sample overheating, chemical decomposition). Drying temperature of

traditional method (using a furnace) is specified in applicable industry or company standards. Unless standards apply, then temperature should be adjusted by tests. On selecting drying temperature value, proceed as follows:

- Determine moisture content in a sample
- Determine temperature of substance chemical decomposition by tests
- Compare result obtained on a moisture analyzer with the one of traditional method

When drying a sample with high moisture content, it is possible to shorten measurement time by selecting “quick” drying mode. In such case, the majority of moisture content is released drying temperature higher than set. Only after some time, the temperature is lowered to the set value, and maintained until completing drying process.

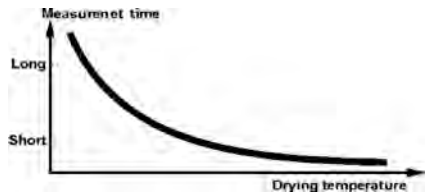

17.4. Selecting drying mode

The software of moisture analyzer enables selecting one of four drying modes:

- Standard
- Quick
- Mild
- Step

STANDARD mode

Standard mode is the most frequently used of all drying modes. It enables accurate determining of moisture content in a dried sample.

MILD mode

Mild mode is used in case of drying substances that are sensitive to rapid heat emitted by filaments operating at full power in the initial stage of drying process. This mode prevents from decomposing of substances sensitive to heat by mild temperature increase in set amount of time (time interval has to be selected by tests). Mild mode is recommended to drying samples of leather structure.

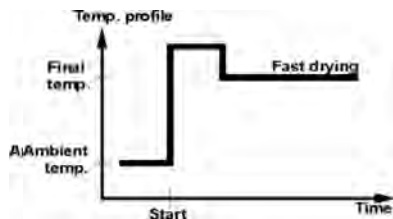

FAST mode

Quick mode is recommended to drying samples that moisture content varies from 5%, and 15%. In the initial stage of Quick mode, heating takes place at full power of the filaments, causing heating the drying chamber to increased temperature (maximum temperature value is higher by 30 % from set drying temperature). Overheating compensates heat loss during evaporation of large moisture content in the test's initial stage.

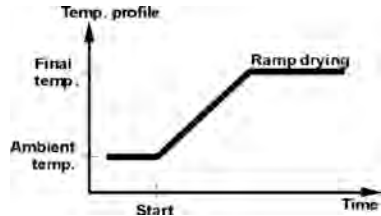

STEP mode

Enables determining up to three steps with random drying temperature. Step mode is recommended for drying substances with moisture content over 15%. Temperature and heating time in each step have to be adjusted by tests.

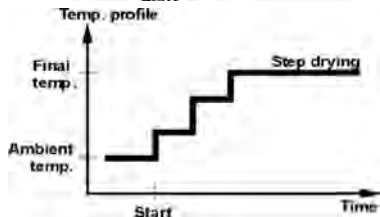

17.5. Drying time

Drying time is set by selecting one of available finish mode criteria. This means that a moisture analyzer must meet pre-set criterion (one of the requirements: mass over time, time) to automatically finish the drying mode.

Finish of drying process can be triggered by amount of time, independently on loss in mass. This criterion is used for substances that may decompose during drying process, and their mass does not reach constant value.

The second criterion is loss in mass (less than 1 mg) in defined amount of time.

Automatic finish mode (Auto switch off mode)

The operator can choose between various types of finish modes:

- Automatic 1 (change 1mg/10s)
- Automatic 2 (change 1mg/25s)
- Automatic 3 (change 1mg/60s)
- Automatic 4 (change 1mg/90s)
- Automatic 5 (change 1mg/120s)
- Time defined (maximum drying time 99 hours 59 minutes)
- Manual (on pressing a function key)
- Defined (Δm – change of mass and Δt – change of time must be given, the former in mg, the later amounts to 120 s. maximally)

Automatic finish mode – user defined criterion (mass/time)

The operator determines the limit value for loss of mass and time in which the loss of mass must not exceed a pre-set value. As the moisture analyzer reaches the set criterion it automatically finishes the measurement (drying process).

Manual finish mode

The operator ends drying process manually by pressing START/STOP soft key on moisture analyzer's display

Time defined finish mode

Drying process finish takes place on elapsing a set amount of time, independently on measurement result.

17.6. Drying mode analysis

For the first case, the drying mode is an asymptote. Moisture content value remains constant even after long drying time. Using this drying mode makes determination of humidity easy. The measurement result is always referred to constant value of asymptote. The result corresponds easily and it is not difficult to select a proper criterion of finish mode

For the second case the drying process is quick at the beginning, next it stabilizes. Moisture content value is never constant. Drying process mode may proceed as follows:

The sample undergoes thermal decomposition, wherein evaporation takes place and as a result the product weigh decreases. Evaporation of grease, oil, plastic or other volatile materials may take much more time than in case of water. Difficult to evaporate materials drop weight.

Result obtained using this mode may be optimistic:

- Lower temperature may slower material reaction.
- Selection of appropriate criterion may let the user recognize end of analysis, within described drying step.
- Constant drying often assures good drying results.
- Maintaining start sample weight permanently (+10%....+20%).

18. FUNCTIONS

- Weighing function
- Drying function

Willing to change the current working mode, the user shall press  button and follow the bellow instruction.

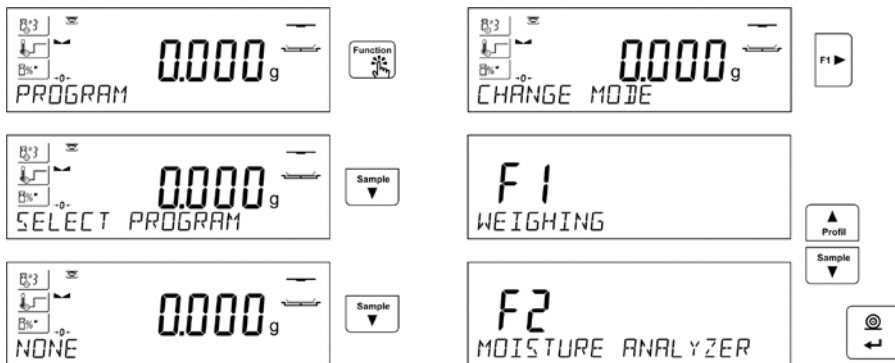

Go to other sections of this manual to read information on function settings.

19. DRYING PROCESS PERFORMED BY MEANS OF QUICK MENU

Current drying parameters are displayed in a form of pictograms on the left. Willing to perform the procedure in accordance with other parameters, the user shall enter settings and modify the respective parameters values.

Entering drying process menu, the user shall set the following parameters:

- Drying process mode and drying process parameters,
- Drying process finish mode and finish mode parameters
- Unit for a displayed and printer result
- Interval for measurement printout, wherein the measurements are printed during the drying process

Willing to change parameters settings, the user shall enter drying process by pressing **Function** button.



19.1. Drying process mode and drying parameters



Upon entering settings for drying parameters, the user shall see word <MODE> and a blinking word standing for mode type. Using arrow buttons select an appropriate mode and press ENTER button to confirm. Upon confirmation the program automatically proceeds to parameters settings.

Drying process mode parameter takes the following values:

- Drying mode **STANDARD**



For standard mode, user shall set drying temperature for which a sample is to be tested.



STANDARD

TEMPERATURE 120°C

- Drying mode **FAST**



For quick mode, user shall set both, length of time for heating in a temperature higher than the preset one and temperature for which a sample is to be tested.



FAST

TIME 000000

TEMPERATURE 120°C

Specific feature of this drying mode is fast increase of drying temperature in short period of time.

When compared to the preset temperature, the drying temperature rises 30% and it is maintained at this level for a specified amount of time, next it drops to temperature value preset in drying mode parameters.

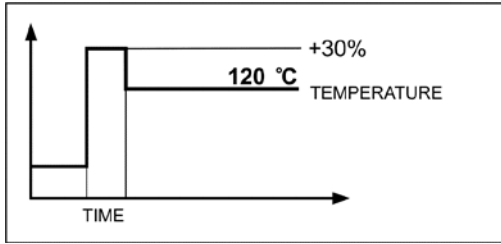

CAUTION:

For **Quick** mode, the user shall set drying temperature and time of heating in 30% higher temperature than the preset temperature. The time is counted from the moment of reaching the respective temperature.

- Drying mode **MILD**



For mild mode, user shall set length of time within which moisture analyzer is to reach specified temperature and temperature for which a sample is to be tested.



MILD

TIME 000000

TEMPERATURE 120°C

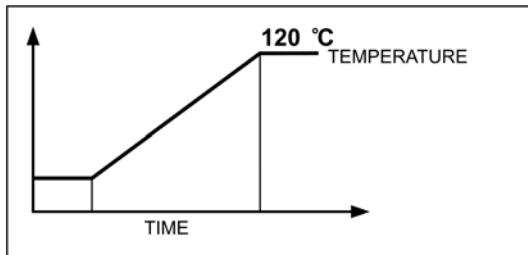

- Drying mode **STEP**



For step mode, user shall set length of time for heating in temperature number one, first step temperature, length of time for heating in temperature number two, second step temperature and temperature for which a sample is to be tested.



STEP

TIME 1 000000
 TEMP 1 000°C
 TIME 2 000000
 TEMP 2 000°C
 TEMPERATURE 120°C

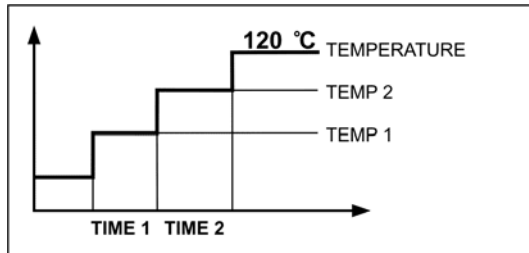

CAUTION:

For **Step** mode, set step temperature „1” and „2” and temperature of drying, set also time length for heating in particular indirect temperatures (1 and 2). Time for heating in particular steps is counted from the moment of reaching a preset temperature for a particular step.

19.2. Auto off mode



```
AUTO 1
AUTO 2
AUTO 3
AUTO 4
AUTO 5
RECZNY
TIME-DEF
TIME 000000
DEFINED
END MASS 00000000
END TIME 000
```

Auto off mode parameter takes the following values:

- a1 - auto switch-off (weight change of 1mg / within time length of 10s)
- a2 - auto switch-off (weight change of 1mg / within time length of 25s)
- a3 - auto switch-off (weight change of 1mg / within time length of 60s)
- a4 - auto switch-off (weight change of 1mg / within time length of 90s)
- a5 - auto switch-off (weight change of 1mg / within time length of 120s)



- manual switch-off (upon pressing **Start/Stop** button.

Maximum time length for drying is 99 hours and 59 minutes. On exceeding this time length the process ends automatically.)



- time-defined switch-off (Maximum time length is 99 hours and 59 minutes):

- a - defined switch-off (weight change within balance range with accuracy of moisture analyzer reading unit / within time length ranging from 1 to 120 seconds.)

19.3. Unit of displayed and printed measurement



- Percent loss of weight,

$\frac{0}{0}^M$

Displays weight change recorded during drying process, expressed in percent,

- Part of dry mass obtained during drying process, expressed in percent,

$\frac{0}{0}^D$

Measurement result is part of mass that is remaining on a drying pan after humidity content evaporation,

- Humid / dry ratio obtained as a result of drying process, expressed in percent,

$\frac{0}{0}^R$

Measurement result is part of mass that evaporated from the dried sample during drying process,

- Weight change

G

Measurement result is mass change recorded during drying process.

19.4. Interval for measurement printout



Time interval between successive printouts of measurements, wherein the printouts are performed in course of drying process. The time interval is expressed in seconds, value range: 0 – 120 s.

20. DRYING PROCESS PERFORMED WITH THE USE OF DRYING PROGRAM LIBRARY

Moisture analyzer can record up to 100 drying programs. The programs may be freely configured, recorded and used.

Willing to use a particular program for a drying process, the user shall:

1. Record procedure to moisture analyzer memory (read instruction in section 14.3. Drying programs).
2. Select the recorded program prior drying. Drying parameters shall be updated to parameters recorded for the selected drying program.

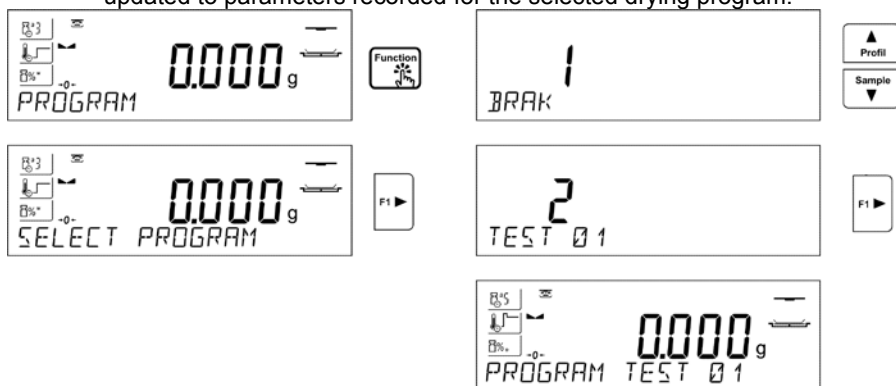

or:

1. Enter data relating to a product/sample that is to be dried, edit product data and set the recorded program as a drying program (read instruction in section 14.2. Products)
2. Prior drying, select the entered product as a current one. Drying parameters shall be updated to parameters recorded for the drying program that is assigned to a selected product.

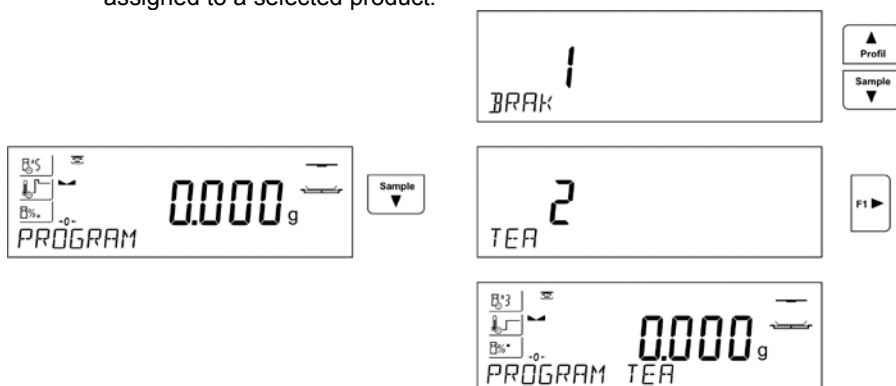

21. DRYING PROCESS

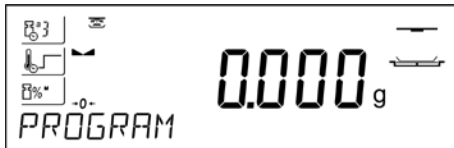

Current drying process settings are displayed in a form of pictograms on the left.



Press Start/Stop button in order to run the drying process
Prompts and messages are displayed making moisture analyzer operation easier.
Follow the prompts to correctly prepare the sample and to perform the process of humidity content determination for a tested sample.



Program prompts the user to prepare a weighing pan, upper top pictogram blinks.

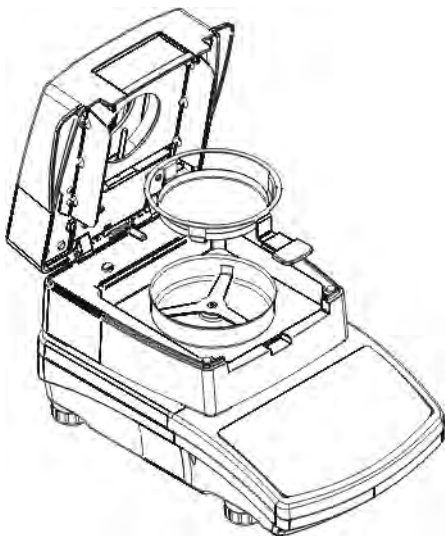

Place the disposable weighing pan in a pan handle and deposit it on a bracket. The display shows disposable pan weight.

It is recommended to close the drying chamber in order to provide stable ambient conditions while tarring.



Using ZERO button, zero the weighing pan weight.

Indication equals ZERO, subsequent prompt is displayed, blinking pictogram swaps to a different one.

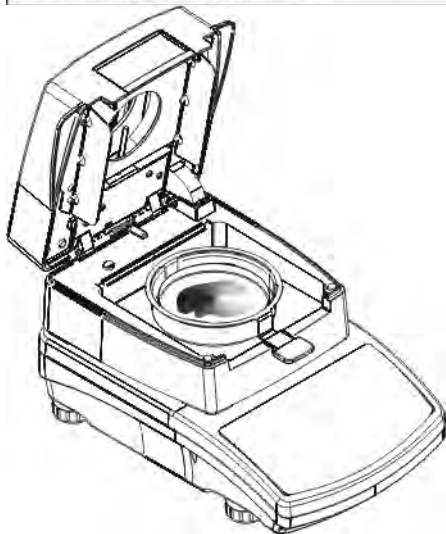

Deposit sample on a weighing pan. Sample weight shall be selected on the basis of prior experience and tested material characteristics.



In course of sample preparation (mass on a weighing pan starts to change) blinking pictogram swaps to a different one. Upon preparing the sample and upon result stabilization (stability pictogram on a display) the user shall close the drying chamber for the drying process to start automatically.

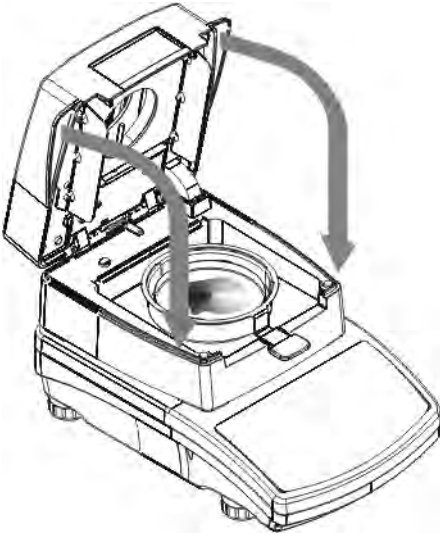

Information on the drying process is displayed, moisture analyzer proceeds to carrying it out accordingly to set parameters. Required weight measurements and calculations of tested sample moisture content are performed, wherein the calculations are a result of weight change. On process start, printout header is sent to a selected interface (accordingly to set printout options – parameter group P5.5 DRYING PROCESS REPORT).



In course of a drying process current weight results and information on the process is displayed (test duration, drying chamber temperature, etc.). In course of a drying process (accordingly to set printout options – parameter group P5.5 DRYING PROCESS REPORT), measurements are sent to a selected communication port in a preset time intervals (INTERVAL).

Units
Esc

UNITS button allows the user to swap between displayed result type.

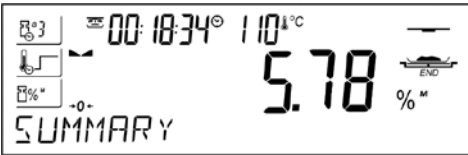

Upon drying process completion, summary of the test is displayed, final humidity result is held. Printout footer is sent to a selected interface (accordingly to set printout options – parameter group P5.5 DRYING PROCESS REPORT).

Drying process may be aborted at any time. Willing to abort the process, the user must press **Start/Stop** button and confirm completion by pressing **Print/Enter** button.

Manual auto switch-off mode is an exception to the rule – for moisture analyzer working in this mode, the drying process ends upon pressing **Start/Stop** button, there is no need to confirm completion by pressing **Print/Enter** button.

In order to return to a main window of drying process settings the user shall open a drying chamber. Moisture analyzer gets back to its initial state, completed process summary is blanked. The moisture analyzer is ready to perform another test.

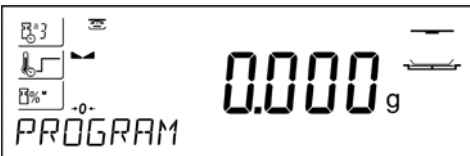

22. COMMUNICATION

Communication menu enables configuration of port settings. The settings are accessed upon pressing  button.

Communication with peripheral devices is established via the following ports:

- COM 1 (RS232),
- USB type A
- USB type B
- WIFI,

Parameters of USB ports are not configurable. The port type B is designed to connect a printer or computer, and the port type A is designed to connect a computer keyboard, bar code reader or USB memory stick.

22.1. RS232 ports settings

Procedure:

- Select <COM 1> communication port,
- Set relevant values

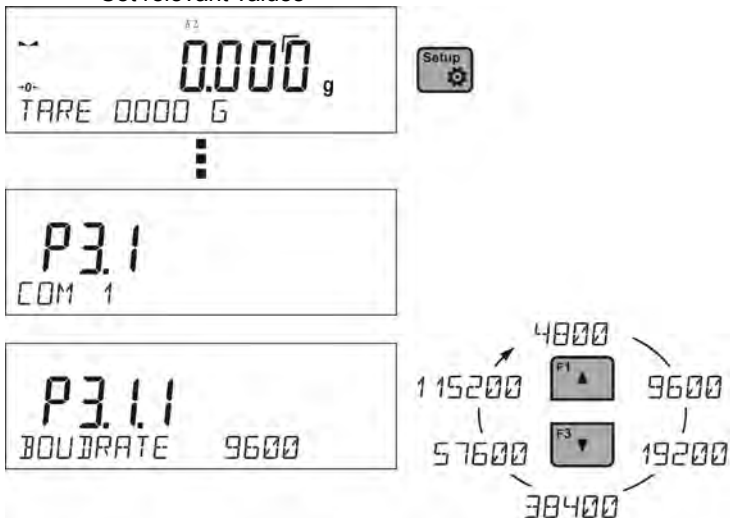

RS232 ports enable the following setting of transmission parameters:

- Baud rate – 2400, 4800, 9600, 19200, 38400, 57600, 115200 bit/s
- Parity – NONE, ODD, EVEN

22.2. USB port

USB port of type A is intended for:

- Connecting a memory stick storing **<FAT files system>**,
- Connecting balance to PCL printer,
- Connecting EPSON TM-T20 printer to USB port

Memory stick may be used for export/import of data stored in balances, or for carrying out measurement data printout (set parameter P4.2.1 <PRINTER/PORT> to <PENDRIVE> option). Measurement data printout operation is described in section 15.3 of this manual.

Please remember that for PCL printer the drivers print completely filled page, i.e. the page will be printed only upon pressing PRINT button, located on a balance, for several times (it depends on a printout size how many times the PRINT button shall be pressed prior printout).

It is possible to obtain printout upon pressing PRINT button once only, supposing that control code <0C> has been set as SUFIX (*for description of this function go to section 23.2 Printer*).

USB port of type B is intended for:

- Connecting balance to a PC computer

In order to make connection of balance and computer possible it is necessary to install virtual COM port in a computer.

To carry out this procedure the user needs a respective driver installer which may be either downloaded from www.radwag.com website or taken from a CD with manuals.

The demanded driver installer is:

R SERIES RADWAG USB DRIVER x.x.x.exe -

Steps:

1. Run driver installer

Setup Wizard welcome window:



Willing to continue click „**Next**” button.

Window for destination folder selection:

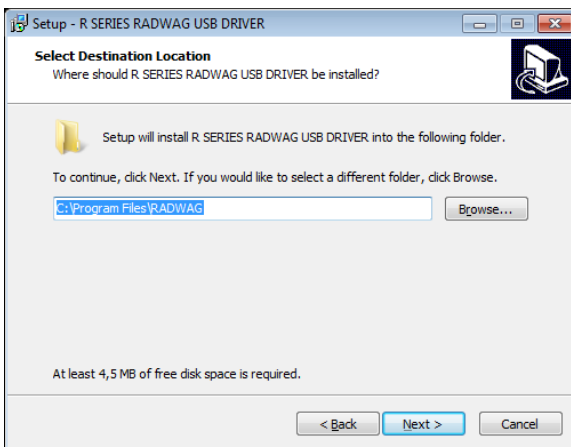

Browse folder tree in order to find destination folder for the program, click „**Next**” button.

„**Ready to install**” window:

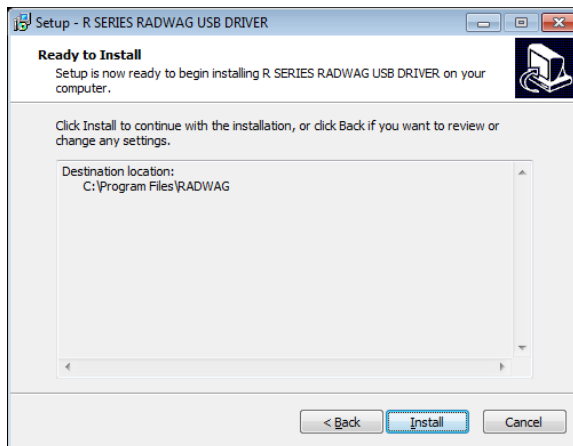

In order to run installation process click „**Install**” button.

In order to run installation process, press “**Install**” key and follow the instruction below, click respective keys presented in the following windows.

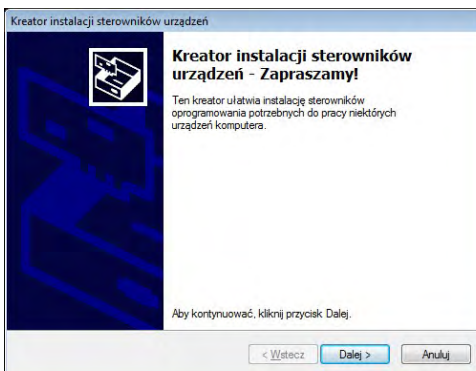

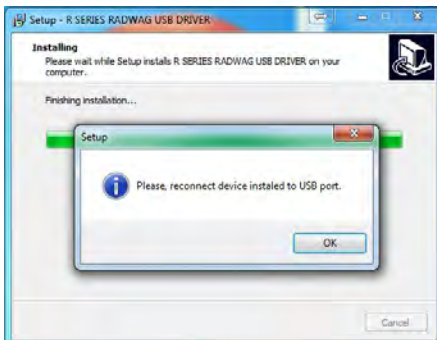
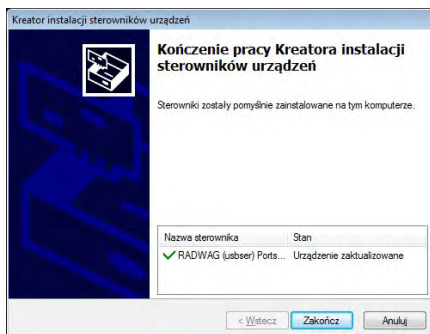
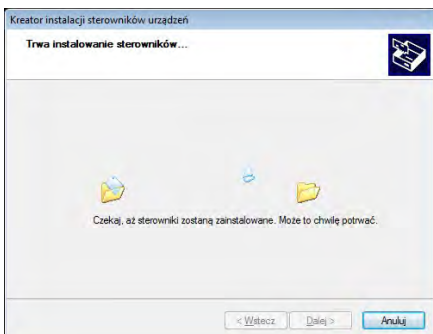
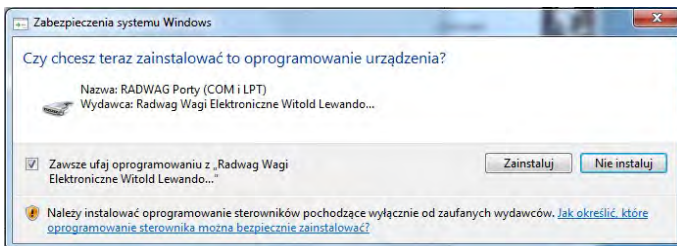

2. Upon driver installation, connect balance to a computer by means of USB A/B cable of length up to 1,8 m (for balance already connected to the computer, it is necessary to perform USB cable disconnection first, and reconnection next).



3. The system detects the new USB device and automatically starts searching a respective driver.
4. Go to Device Manager and check number assigned to virtual COM port:

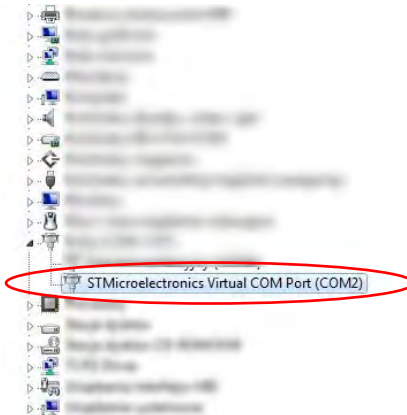

For this very case the COM port number is COM2 – STMicroelectronics.

5. Set balance parameters: select USB value for parameter P4.1.1 COMPUTER/PORT.
6. Run software for measurement readout.
7. Use the program to set parameters for communication – select respective COM port (for the very case it is COM2), i.e. the one which has been formed while installing drivers.
8. Start cooperation.

22.3. WIFI port settings

CAUTION:

1. The transmission parameters must be matched to the customer's local network.
2. Most Wi-Fi modules operate using one channel, defined during Wi-Fi network configuration.
3. To ensure proper Wi-Fi router cooperation (the router changes channels automatically), set <AUTOCHANNEL> parameter to <YES> value while configuring connection.
4. To ensure proper communication with a computer by means of WiFi, enter balance settings and set interface parameter to <WIFI> value: **P4.1.1 <DEVICES/COMPUTER/PORT/WIFI>**.
5. To ensure cooperation with ANDROID applications set parameter P4.1.4 <DEVICES/COMPUTER/PRINTOUT> to value <**STANDARD**>.

Parameters available for Wi-Fi connection settings:

P3.3.1 – STATUS

P3.3.2 – CHOOSE NETWORK

P3.3.3 – NETWORK SETTING

P3.3.3.1 – NAME (the name of the network that has been selected)

P3.3.3.2 – PASSWORD (password – 'stars' are displayed)

P3.3.3.3 – CHANNEL NO (default <AUTO>)

P3.3.3.4 – IP (balance ID number, make sure that the number is not engaged by a different device using this network)

P3.3.3.5 – MASK (default 255.255.000.000)

P3.3.3.6 – GATE (default 10.10.8.244)

P3.3.3.7 – PORT (default 4000)







P3.3.3.8 – MAC ADRES (0008DC...)

P3.3.4 – WIFI STARTUP

After entering the parameter, message <STATUS> and value describing the connection status for Wi-Fi network appear in the bottom line of a display.

- **CONNECT** – the balance is connected to one of the available Wi-Fi networks, additionally, at the top  pictogram turns up and stays visible as long as network connection is active.
- **CONNECTIVITY** – the balance is trying to re-establish connection with the previously connected network, suitable for previously entered settings (network, IP, etc.)
- **NONE** – Wi-Fi module is not installed in the balance.

Procedure:

- Select <WIFI> communication port, next set appropriate values for the parameter <P3.3.3 – NETWORK PARAMETERS: IP; MASK; GATEWAY; PORT>
- enter the parameter <P3.3.2 – SELECT NETWORK> and start the procedure of searching for available networks by pressing  button. Search procedure starts and after its completion the first network detected by the balance appears in the bottom line.
- Use  or  buttons to select the demanded network and press .
- Message <PASSWORD*****> appears in the bottom line. Use a computer keyboard connected to USB port to easily enter the case-sensitive password. Enter the network password and confirm it by pressing  button.
- The balance software automatically guides the user through basic network parameters such as: CHANNEL AUTO (YES/NO), IP, MASK, GATE. Default parameter values are stored in the program. They can be changed by the user according to his/her needs. Pay special attention to <CHANNEL AUTO> parameter, when <YES> option is selected, the balance Wi-Fi module automatically checks if the channel remains unchanged, in case of modifications the module automatically adjusts to the new router channel. For a router changing channels automatically this option eliminates the need to modify Wi-Fi module settings.
- The balance returns to displaying parameter <P3.3.2 – SELECT NETWORK>.
- Upon entering a respective password the balance automatically connects to the selected network.
- Go to the parameter <P3.3.1 – STATUS>, message <CONNECTIVITY> is displayed meaning that the balance is trying to connect to the network using the settings.
- When the balance connects to Wi-Fi network, the status changes to <CONNECT>,  pictogram is displayed.
- If the balance cannot connect to the network for a long time (<CONNECTIVITY> status being displayed), it is likely that network parameters have been incorrectly entered.
- Ensure that the settings are correctly entered, and repeat the connecting process.
- If this fails, contact your RADWAG service representative.

23. PERIPHERALS

Menu PERIPHERALS is comprised within menu Parameters. In order to access the menu press  button.

The menu provides a list of devices which can cooperate with the balance.

23.1. Computer

Submenu <COMPUTER> allows the user to select a port for connection of a computer, running software which enables communication with a balance, switching the continuous transmission on and off and cooperation of a balance with E2R software of Radwag production.

23.1.1. Port for computer connection

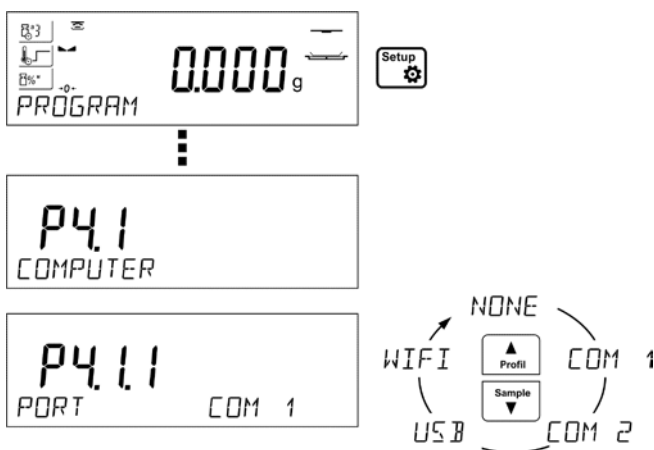

Procedure:

- press  button
- enter menu <P4 DEVICES>
- enter menu group <P4.1 COMPUTER>
- set the parameters related to cooperation with a computer, <P4.1.1 PORT> to which the computer is to be connected.

Accessible options:

- COM 1** – RS 232 port, to which the computer is connected
- USB** type B – USB port, to which the computer is connected
- WIFI** – WIFI port

23.1.2. Continuous transmission

Continuous transmission parameter enables turning on/off continuous transmission of a measurement.

It is possible to set one of three available options:

- Continuous transmission in a calibration unit <CAL. UNIT>, independently from currently chosen weight unit, measurements are transmitted in unit set on a main measuring device (calibration unit)
- Continuous transmission in a current unit <CURRENT UNIT> measurements are transmitted in a current unit; the unit changes dynamically whenever the user presses Units button in order to modify the unit on a display.
- Continuous transmission off <NONE>

Setting instruction:

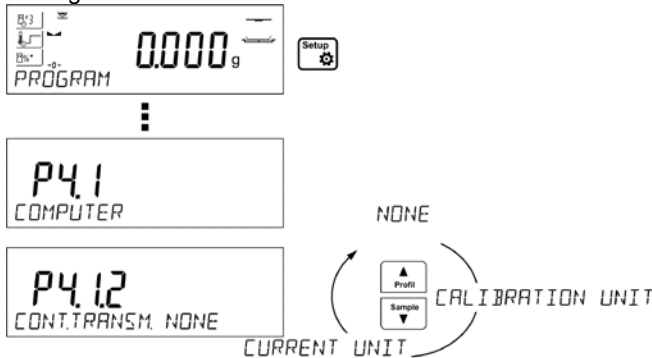

Caution:

Continuous transmission may be turned on/off by means of command sent from a computer (go to COMMUNICATION PROTOCOL section).

23.1.3. Printouts interval for continuous transmission

Parameter <P4.1.3. INTERVAL> enables setting frequency of printouts for continuous transmission.

Frequency of printouts is set in seconds, wherein the accuracy is 0.1s.

The user may set any time value ranging from 1000 to 0.1 s.

The setting is valid for continuous transmission in calibration unit and in current unit activated by means of the balance (see parameter P4.2.1.2), it is also valid for continuous transmission activated by command sent from a computer (see section 25 COMMUNICATION PROTOCOL).

23.1.4. Cooperation with E2R

E2R is a control system, it controls all weighments performed on a balance. Upon activation of this option, operations on some Databases are possible only with the use of a computer (options are not accessible on a balance). In order to start cooperation with E2R system set <YES> value of <E2R SYSTEM> parameter.

Caution:

< **E2R System** > parameter activation may be carried out by the device manufacturer or authorized persons, exclusively.

23.2. Printer

Submenu <PRINTER> allows the user to choose a port and a device, to which the



data is to be sent upon pressing button on balance. Content of data being transferred is set in parameter <PRINTOUTS/PRINTOUT GLP>.

Procedure:

- press  button
- enter the menu <P4 DEVICES>
- enter menu group <P4.2 PRINTER>
- set balance parameters related to cooperation with the printer <P4.2.1 PORT> to which the printer is to be connected

Accessible options:

COM 1 – RS 232 port, to which the printer is connected

USB type A – USB port, to which PCL printer or EPSON printer is connected

WIFI –WIFI port, which can send data to special, RADWAG-manufactures software, e.g. WIN measurement, run by means of a computer connected to the balance via WIFI.

USB memory stick – USB port type A, to which external memory flash drive is connected

USB PC – USB port type B, to which a computer with special software by RADWAG is connected, e.g. WIN measurement.

Example of the measurement printout is described in the PRINTOUTS section.

Additionally the user can send a controlling code (of a hexadecimal form) to a printer either at the beginning of the printout - <P4.2.2 PREFIX> or at the end of it - <P4.2.3 SUFFIX>. Sending these codes allows to control globally both, information

and actions carried out at the beginning and/or at the end of each printout sent from a balance to a printer.

This function is most frequently used to send an information about the code page of a printout sent by a balance, at the beginning, and to send a command enabling the crop of a paper in EPSON printers (if the printer is equipped with an autotripper blade), at the end.

<PREFIX> and <SUFFIX> parameters settings are available for all the printouts sent from balance, e.g. calibration reports, density, statistics etc., and for the header, footer and GLP printouts.

CAUTION:

It must be remembered that inserting paper crop command to <SUFFIX> parameter (control code) results in sending the code after each printout. If the user wishes for one whole printout to consist of: HEADER, GLP PRINTOUT and FOOTER and to be cropped underneath the FOOTER, then the paper crop command should be inserted only for FOOTER settings as a non-standard printout with <%E> value (paper crop for EPSON printer). In such a case <SUFFIX> command must remain empty.

To ensure correct cooperation of the balance with the printer (correct printout of diacritical signs of a given language), respective baud rate obligatory for a given printer must be chosen (see the printer settings). Additionally code page of a sent printout must be accordant with a code page of a printer.

Accordance of a code page may be obtained in two ways:

- setting the right code page in the settings of a printer (see a user manual of the printer) – it must be accordant with the printout code page of a balance (**1250** code page for POLISH, CZECH, HUNGARIAN; **1252** for ENGLISH, GERMAN, SPANISH, FRENCH, ITALIAN; **1254** for TURKISH),
- sending the control code from the balance, automatically setting the right code page of the printer (code page accordant with the one of a balance) prior printout of data taken from the balance (this possibility is available only for printers with such option – see a user manual of the printer).

CUTION: CODES MUST BE ENTERED IN A HEXADECIMAL FORM!

Example balance settings for correct cooperation with **TM-U220B EPSON dot matrix printer** connected to RS232 port (since only 852 code page is available for this printer, there won't be any Polish signs on a printout):

Communication parameters for port to which the printer is connected:

- BAUD RATE - 9600 bit-s
- PARITY – none

Printer parameters for PERIPHERALS group:

PORT – COM1

PREFIX - **1B742D** (1250 code page)

SUFFIX - **1D564108** (paper crop for EPSON printers equipped with an auto cutter blade)

Example balance settings for correct cooperation (printout of Polish signs) with **TM-T20 EPSON thermal printer** connected to RS232 port; if the printer is connected to USB port than the transmission speed settings and parity do not matter:

Communication parameters of port to which the printer is connected:

- BAUDRATE - 38400 bit-s
- PARITY – none

Printer parameters for PERIPHERALS group:

- PORT – COM1
- PREFIX - **1B742D** (1250 code page)
- SUFFIX - **1D564108** (paper crop for EPSON printers equipped with an auto cutter blade)

If on the printout in the place of the last digit there are any unexpected signs (for verified balances), than <P4.2.2 PREFIX> parameter should incorporate, apart from code page, code of the UK signs chart: **1B5203**. In such a case the <P4.2.2 PREFIX> parameter setting should be as follows:

- PREFIX - **1B742D1B5203** (1250 code page and UK signs chart)

Control codes for exemplary code pages:

<i>Control code</i>	<i>Page or other command</i>
1B742D	code page 1250
1B7410	code page 1252
1B7430	code page 1254
1B5203	UK signs chart
1B5202	DE signs chart
1D564108	Paper crop
0C	Form feed (for PCL printers)

23.3. Barcode reader

Submenu <BARCODE READER> includes balance settings for cooperation with a barcode reader.

Procedure:

- press  button
- enter the menu <P4 DEVICES>
- enter menu group <P4.3 BARCODE READER>
- set the balance parameters related to cooperation with a barcode reader

<P4.3.1 PORT> - choice of port, to which the barcode reader is to be connected

- o accessible options: NONE, COM 1

24. COOPERATION WITH PERIPHERALS (PRINTER, COMPUTER ETC.)

CAUTION



A peripheral device that is connected to RS 232 or USB port of a balance, has to be powered from the common low voltage power network equipped with common anti-shock protection in a way to preclude possible occurrence of different potentials in zero cables of the peripheral device and the balance.



Balance transmission parameters must correspond to the parameters of a device that is connected to the balance.

- Baud rate - 4800 ÷ 115200 bit / s
- Parity control - NONE, ODD, EVEN

Value indicated on a display can be sent via RS232 or USB port to a peripheral device in one of four accessible ways:

- manually - on pressing  button
- automatically - on stabilisation of weighing result
- continuously - on activation of a function or sending a command
- on command sent from a peripheral device (see additional functions).

Value indicated on a display can be sent via COM port or USB port in the following form:

- stable - data is sent immediately on stabilisation of weighing result
(button )
- unstable - on pressing  button, display status is sent immediately to a peripheral device (on a printout such status is marked with <?> symbol located in front of the weighing result). This option is only available for non-verified balances.

24.1. Cables



Cable: balance – computer (RS232)

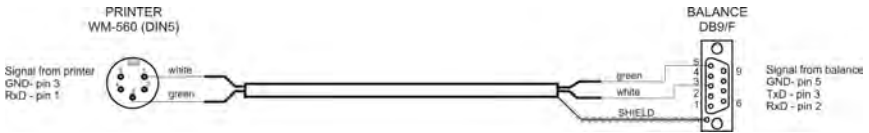

Cable: balance – KAFKA printer

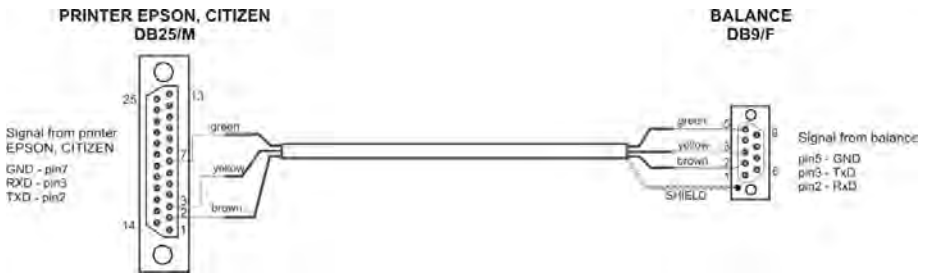

Cable: balance – printer (CITIZEN, EPSON)

24.2. Transferred data format

The measurement result can be transferred from a balance to an external device

by pressing  button, located on the balance, or by sending a control command from a computer.

24.3. Format of data sent on pressing PRINT button



CAUTION

Unstable measurement printout is not available for a verified balance.

Printout format

1	2	3	4 - 12	13	14 - 16	17	18
stability marker	space	character	mass	space	unit	CR	LF

- stability marker - [space] – if stable
 - [?] – if unstable
 - [^] - if maximum range is exceeded
 - [v] - if minimum range is exceeded
- character - [space] - for positive values or [-] for negative values
- mass - 9 characters with right justification
- unit - 3 characters with left justification

24.3.1. Format of data sent as response for commands generated from a computer

Waga po przyjęciu rozkazu odpowiada najpierw:

- XX_A CR LF - command understood and in progress
- XX_I CR LF - command understood but not accessible at this moment
- XX_^ CR LF - command understood but maximum range is exceeded
- XX_v CR LF - command understood but minimum range is exceeded
- XX_E CR LF - an error occurred on command carrying out - time limit exceeded while waiting for stable measurement result (time limit is module's characteristic parameter)
- XX - name of the command

next:

1 - 3	4	5	6	7	8 - 16	17	18 - 20	21	22
Command	space	stability marker	space	character	mass	space	unit	CR	LF

- command - 1 ÷ 3 - characters
- stability marker - [space] – if stable
 - [?] – if unstable
 - [^] - if maximum range is exceeded
 - [v] - if minimum range is exceeded
- character - [space] – for positive values, [-] for negative values
- mass - 9 characters with right justification
- unit - 3 characters with left justification

25. COMMUNICATION PROTOCOL

General information

- A. A character based communication protocol balance-terminal is designed for establishing communication between a RADWAG balance and peripheral devices via RS 232 interface.
- B. It consists of commands sent from a peripheral device to the balance and responses from the balance.
- C. Responses are sent from the balance on each receipt of a command as a reaction to a specific command.
- D. Commands forming the communication protocol enable both, obtaining data on balance status and influencing its operation, e.g.: acquiring measurement results from the balance, zeroing, etc.

25.1. List of commands

Command	Command description
Z	Zero balance
T	Tare balance
OT	Give tare value
UT	Set tare
S	Send stable measurement result in basic measuring unit
SI	Immediately send measurement result in basic measuring unit
SU	Send stable measuring result in current measuring unit
SUI	Immediately send measurement result in current measuring unit
C1	Switch on continuous transmission in basic measuring unit
C0	Switch off continuous transmission in basic measuring unit
CU1	Switch on continuous transmission in current measuring unit
CU0	Switch off continuous transmission in current measuring unit
NB	Give balance serial number
K1	Lock balance keypad

K0	Unlock balance keypad
SS	Value release
OMI	Give available working modes
OMS	Set working mode
OMG	Give current working mode
BP	Activate sound signal
PC	Send all implemented commands

Caution:

Each command must end with CR LF characters; the spaces provided in the formats should be omitted, they are included only to improve readability.

25.2. Responses format to commands sent from a computer level

On receipt of a command, the terminal sends a response in one of the following formats:

XX_A CR LF	command understood and in progress
XX_D CR LF	command carried out (appears only after the command XX_A)
XX_I CR LF	command understood but not accessible at this moment
XX_^ CR LF	command understood but max range is exceeded
XX_v CR LF	command understood but min range is exceeded
XX_OK CR LF	command carried out
ES_CR LF	command not recognised
XX_E CR LF	time limit exceeded while waiting for stable measurement result (time limit is balance characteristic parameter)
XX	- stands for a name of sent command
_	- stands for spaces

21.3. Commands description

Zero balance

Format: **Z CR LF**

Accessible responses:

- Z_A CR LF - command understood and in progress
- Z_D CR LF - command carried out
- Z_A CR LF - command understood and in progress
- Z^ CR LF - command understood but zeroing range exceeded
- Z_A CR LF - command understood and in progress
- Z_E CR LF - time limit exceeded while waiting for stable measurement result
- Z_I CR LF - command understood but not accessible at this moment

Tare balance

Format: **T CR LF**

Accessible responses:

- T_A CR LF - command understood and in progress
- T_D CR LF - command carried out
- T_A CR LF - command understood and in progress
- T_v CR LF - command understood but taring range exceeded
- T_A CR LF - command understood and in progress
- T_E CR LF - time limit exceeded while waiting for stable measurement result
- T_I CR LF - command understood but not accessible at this moment

Give tare value

Format: **OT CR LF**

Accessible response: **OT_TARA CR LF** – command carried out

Response format:

1	2	3	4-12	13	14	15	16	17	18	19
O	T	space	tare	space	unit			space	CR	LF

- Tare - 9 characters with right justification
- Unit - 3 characters with left justification

CAUTION: Tare value is always given in adjustment unit.

Set tare

Format: **UT_TARA CR LF**, where **TARE** – tare value

Accessible responses:

- UT_OK CR LF - command carried out
- UT_I CR LF - command understood but not accessible at this moment
- ES CR LF - command not recognised (tare format incorrect)

CAUTION: Use dot in tare format as decimal point.

Send stable measurement result in basic measuring unit

Format: **S CR LF**

Accessible responses:

- S_A CR LF - command understood and in progress
- S_E CR LF - time limit exceeded while waiting for stable measurement result
- S_I CR LF - command understood but not accessible at this moment
- S_A CR LF - command understood and in progress
- MASS FRAME - response is mass value in basic measuring unit

Response format:

1	2-3	4	5	6	7-15	16	17	18	19	20	21
S	space	stability marker	space	character	mass	space	unit			CR	LF

Example:

- S CR LF** – command sent from a computer
- S _ A CR LF** – command understood and in progress
- S _ _ _ _ - _ _ _ _ _ 8 . 5 _ g _ _ CR LF** – command carried out, response is weight value in basic measuring unit.

Immediately send measurement result in basic measuring unit

Format: **SI CR LF**

Accessible responses:

- SI_I CR LF - command understood but not accessible at this moment
- MASS FRAME - response is immediate with weight value in basic weighing unit

Response format:

1	2	3	4	5	6	7-15	16	17	18	19	20	21
S	I	space	stability marker	space	character	mass	space	unit			CR	LF

Example:

- SI CR LF** – command sent from a computer
- SI _ ? _ _ _ _ _ 1 8 . 5 _ k g _ CR LF** – command carried out, immediate response of weight value in a basic weighing unit.

Send stable measurement result in current weighing unit

Format: **SU CR LF**

Accessible responses:

- SU_A CR LF - command understood and in progress
- SU_E CR LF - time limit exceeded while waiting for stable measurement result
- SU_I CR LF - command understood but not accessible at this moment
- SU_A CR LF - command understood and in progress
- MASS FRAME - response is mass value in current measuring unit

Response format:

1	2	3	4	5	6	7-15	16	17	18	19	20	21
S	U	space	stability marker	space	character	mass	space	unit			CR	LF

Example:

S U CR LF – command sent from a computer

S U _ A CR LF – command understood and in progress

S U _ _ _ - _ _ 1 7 2 . 1 3 5 _ N _ _ CR LF – command carried out
response is mass value in current measuring unit.

Immediately send measurement result in current measuring unit

Format: **SUI CR LF**

Accessible answers:

SUI CR LF - command understood but not accessible at this moment

MASS FRAME - mass value in current measuring unit is returned immediately

Response format:

1	2	3	4	5	6	7-15	16	17	18	19	20	21
S	U	I	stability marker	space	character	mass	space	unit			CR	LF

Example:

SUI CR LF – command from a computer

SUI ? _ - _ _ _ 5 8 . 2 3 7 _ k g _ CR LF – command carried out,
immediate response of mass value in current measuring unit
where: _ - space

Switch on continuous transmission in basic measuring unit

Format: **C1 CR LF**

Accessible answers:

C1_I CR LF - command understood but not accessible at this moment

C1_A CR LF - command understood and in progress

MASS FRAME - response is mass value in basic measuring unit

Response format:

1	2	3	4	5	6	7-15	16	17	18	19	20	21
S	I	space	stability marker	space	character	mass	space	unit			CR	LF

Switch off continuous transmission in basic measuring unit

Format: **C0 CR LF**

Accessible responses:

- C0_I CR LF - command understood but not accessible at this moment
- C0_A CR LF - command understood and carried out

Switch on continuous transmission in current measuring unit

Format: **CU1 CR LF**

Accessible responses:

- CU1_I CR LF - command understood but not accessible at this moment
- CU1_A CR LF - command understood and in progress
- MASS FRAME - response is mass value in current measuring unit

Response format:

1	2	3	4	5	6	7-15	16	17	18	19	20	21
S	U	I	stability marker	space	character	mass	space	unit			CR	LF

Switch off continuous transmission in current weighing unit

Format: **CU0 CR LF**

Accessible responses:

- CU0_I CR LF - command understood but not accessible at this moment
- CU0_A CR LF - command understood and carried out

Give balance serial number

Format: **NB CR LF**

Accessible responses:

- NB_A_”x” CR LF - command understood, returns serial number
- NB_I CR LF - command understood but not accessible at this moment

x – serial number of the device (inserted inbetween inverted commas)

Example:

Command:

NB CR LF – give serial number

Response:

NB_A_”1234567” – serial number of the device – ”1234567”

Lock balance keypad

Format: **K1 CR LF**

Accessible responses:

- K1_I CR LF** - command understood but not accessible at this moment
- K1_OK CR LF** - command carried out

Command locks the balance keypad (proximity sensors, touch panel) until the moment of turning the balance off or until sending K0 command.

Unlock balance keypad

Format: **K0 CR LF**

Accessible responses:

- K0_I CR LF** - command understood but not accessible at this moment
- K0_OK CR LF** - command carried out

Value release

Format: **SS CR LF**

Accessible responses:

- SS_OK CR LF** - command understood, execution in progress

Command's function is similar to function of button PRINT located on an overlay, the function is performed according to balance settings for value release.

OMI - Give available working modes

Command overview:

Command returns accessible working modes.

Format: **OMI <CR><LF>**

Accessible responses:

- OMI <CR><LF>** - command carried out, accessible working
- n_ "Mode name" <CR><LF>**: modes returned
- n_ "Modename" <CR><LF>**
- OK <CR><LF>**
- OMI_I <CR><LF>** - command understood but not accessible at this moment

Mode name – parameter, working mode name, inserted in between inverted comas. The name takes form given on a particular balance display, it is provided in a currently selected language.

n – parameter, decimal value determining working mode number

n → 1 – Weighing

17 – Moisture analyzer

CAUTION: Working modes numbering is identical for each kind of balance. The numbers are assigned to working modes names. Some balances give only the number as a response.

Example 1:**Command:**

OMI <CR><LF>

– give accessible working modes

Response:

OMI <CR><LF>

– accessible working modes are given
number + name

1_ "Weighing" <CR><LF>

17_ "Moisture analyzer" <CR><LF>

OK <CR><LF>

– command carried out

Example2:**Command:**

OMI <CR><LF>

– give accessible working modes

Response:

OMI <CR><LF>

– accessible working modes are given
(mode number)

1 <CR><LF>

17 <CR><LF>

OK <CR><LF>

– command carried out

OMS - Set working mode

Command overview:

Command sets accessible working modes.

Format: **OMS_n <CR><LF>**

Accessible responses:

OMS_OK <CR><LF> - command carried out**OMS_E <CR><LF>** - error in-course of command execution, no parameter
or incorrect format**OMS_I <CR><LF>** - command understood but not accessible at this
moment**n** – parameter, decimal value determining working mode number. To see detailed
description go to OMI command.**Example:****Command:**

OMS_1<CR><LF>

– set working mode weighing

Response:

OMS_OK<CR><LF>

– working mode weighing selected

OMG - Give current working mode

Command overview:

Command gives selected working modes.

Format: **OMG <CR><LF>**

Accessible responses:

- OMG_n_OK <CR><LF>** - command carried out, number of current working mode given
- OMG_I <CR><LF>** - command understood but not accessible at this moment

n – parameter, decimal value determining working mode number. To see detailed description go to OMI command.

Example:

Command:

OMG<CR><LF>

– give current working mode

Response:

OMG_17_OK<CR><LF>

– balance operates in working mode
Moisture Analyzer

BP – Activate sound signal

Command overview:

Command activates BEEP sound signal for a specified amount of time.

Format: **BP_TIME <CR><LF>**

Accessible responses:

- BP_OK <CR><LF>** - command carried out, BEEP sound signal activated
- BP_E" <CR><LF>** - no parameter or incorrect format
- BP_I <CR><LF>** - command understood but not accessible at this moment

TIME – parameter, decimal specifying how long shall the sound last, parameter given in [ms]. Recommended range <50 - 5000>.

If value greater than the permissible high limit is given, than BEEP sound is operated for the maximum permissible amount of time.

Example:

Command:

BP_350<CR><LF>

- activate BEEP for 350 ms

Response:

BP_OK<CR><LF>

- BEEP activated

CAUTION! – BEEP sound activated via BP command is inhibited if in-course of its activation the sound is activated by means of other device: keypad, touch panel, proximity sensors.

Send all the implemented commands

Format: **PC CR LF**

Response: **PC_A "Z, T, S, SI, SU, SUI, C1, C0, CU1, CU0, NB, K1, K0, SS, OMI, OMS, OMG, BP, PC "**

26. ERROR MESSAGES

-Err2-	Value beyond zero range
-Err3-	Value beyond tare range
-Err8-	Tarring / Zeroing operation time exceeded
-NULL-	Zero value from converter
-FULL-	Measurement range exceeded
-LH-	Start mass error

27. USING MOISTURE ANALYZER

For measurement temperatures ranging from 161°C to 250°C the time of maintaining the temperature during the measurement is estimated proportionally, ~15 hours for 161°C – 10 min for 250°C.

For a drying process carried out in 250°C, Max temp is maintained for 10 min, next the program automatically lowers the temperature (drying is not interrupted) to 160°C.

Lowering temperature to 160°C takes ~10 min.

For QUICK drying mode Max drying temperature remanipulation is 30% but no more than Max temperature for a particular moisture analyzer.

28. ADDITIONAL EQUIPMENT

28.1. Anti-vibration table



It is a very stable basis which eliminates all kinds of vibrations and ground shakes. The inner part of the table holds a marble plate, which is a foundation for balance positioning.

29. MAINTENANCE ACTIVITIES

This section of the user manual describes procedures of maintaining a moisture analyzer in good condition, and means of replacing faulty components (filaments, fuses).

29.1. Cleaning moisture analyzer components

In order to ensure required measuring accuracy, the moisture analyzer has to be used and stored in clean conditions.

While cleaning the moisture analyzer, precautions provided in this section of the user manual must be obeyed.



REMEMBER, before initiating any maintenance or cleaning activities of moisture analyzer's inner parts (including a fuse of a filament), switch off the moisture analyzer and make sure the power cord of the moisture analyzer is unplugged from mains!

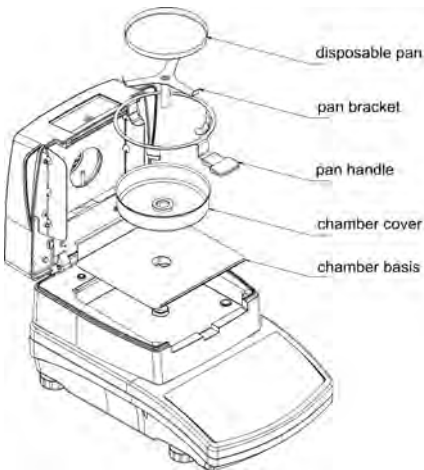

Open moisture analyzer's lid and take out all components of the drying chamber: disposable pan, pan bracket, cross shaped pan handle, drying chamber's cover, insert of the drying chamber's basis.

Clean the moisture analyzer using soft fabrics (diaper, chamois, etc.) and non-aggressive cleaning agents.

Do not use any abrasive agents or solvents to clean the moisture analyzer, as it may cause damage to the device and its components.

After cleaning, thoroughly dry each of moisture analyzer's components. Do not allow any contamination or liquid to fall into the moisture analyzer.

Assembly cleaned and dried components in accordance with above scheme.

26.1. Temperature sensor cleaning

In order to ensure correct temperature measurements during testing procedure, pay special attention to cleanness of the temperature sensor (1).

Any cleaning activities of the temperature sensor should be carried out while maintaining special precautions. Temperature sensor should be cleaned using a soft fabric with addition of mild detergents. Do not use any abrasive agents or solvents, as they may damage the temperature sensor.

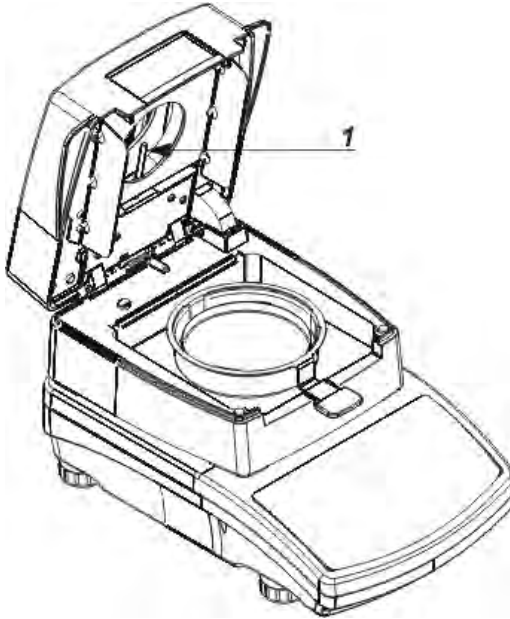

While cleaning make sure not to touch heating filament so as not to damage it.

If necessary it is permissible to clean filament's shield. Clean the filament's shield using a soft and dry fabric only. Do not touch the filament while cleaning the shield.

26.2. Troubleshooting

Problem: no reaction to pressing main switch on/off key (display remains dark).

Probable cause:

- No voltage in mains
- Damaged power cord
- Damaged fuse of the moisture analyzer
- Moisture analyzer defect

Problem: too long pending time for drying process finish.

Probable cause:

- Selected finish mode of drying process is incorrect. Carry out experimental tests to select a proper means of finish mode.

Problem: measurements are not repeatable

Probable cause:

- non-uniform sample content. Prepare the sample using larger amount of substance.
- the drying time is too short. Change testing process finish mode criteria.
- drying temperature is too high, causing sample's oxidizing. Lower drying temperature.
- tested sample boils. Lower the drying temperature.
- the temperature sensor is contaminated or defected. Clean the temperature sensor.
- the weighing table on which the moisture analyzer is located is unstable. Change the location of instrument's operation.
- the ambient area is incompatible with the requirements (vibrations, drafts, etc.). Change the ambient conditions for compatible ones according to the guidelines of this user manual.

*User manual no:
IMMU-14-04-12-14-ENG*

MANUFACTURER
OF ELECTRONIC WEIGHING
INSTRUMENTS



RADWAG BALANCES AND SCALES
POLAND, 26 – 600 Radom, Bracka 28

Phone: +48 48 38 48 800, phone/fax: + 48 48 385 00 10

Sales department: + 48 48 366 80 06

export@radwag.com

www.radwag.com

